



2Din CD Premium Audio

2Din CD Basic Audio

TOYOTA PART NO. PC601-00027

PC601-00028

PC601-00029

PC601-00031

## **Owner's Manual**

Thank you for your purchase of the TOYOTA Genuine AUDIO System.  
Please note that this manual explains all functions and equipment, including options.  
Therefore, you may find some explanations for features or equipment not included in your AUDIO system.

**TOYOTA DAIHATSU ENGINEERING & MANUFACTURING CO.,LTD.**

# CONTENTS

IMPORTANT SAFETY INFORMATION	2
BEFORE USE	3
BASIC OPERATIONS	5
Buttons overview	
Remote control	
Operations using the steering switch	
BASIC SETTINGS	14
Clock settings	
System settings	
Audio settings	
Display settings	
RADIO	19
CD	20
USB	22
iPod	24
AUX	26
BLUETOOTH®	26
REFERENCES	31
TROUBLESHOOTING	32
SPECIFICATIONS	34
SOFTWARE LICENSE AGREEMENT	35
IMPORTANT NOTICE	37

## In case of trouble

Should this product fail to operate properly, contact your dealer or nearest authorised Toyota Service Station.

## How to read this manual

- Operations are explained mainly using buttons on the touch panel of models with Bluetooth features (left-hand drive model).
- The displays shown in the examples may differ from actual displays, which may be changed without notice for performance and function improvements.
- English indications are used for the purpose of explanation. You can select the display language from the [FUNCTION] menu. (→ 15)
- [XX] indicates the selected items.
- (→ XX) indicates references are available on the stated page.

# IMPORTANT SAFETY INFORMATION

For safety reasons, this owner's manual indicates items requiring particular attention with the following marks.

## WARNING

- This is a warning against anything which may cause death or serious injury to people if the warning is ignored. You are informed about what you must or must not do in order to reduce the risk of death or serious injury to yourself and others.

## CAUTION

- This is a warning against anything which may cause injury to people if the warning is ignored. You are informed about what you must or must not do in order to reduce the risk of injury to yourself and others.

## Precautions

### IMPORTANT

To ensure proper use, please read through this manual before using this product. It is especially important that you read and observe WARNINGS and CAUTIONS in this manual. Please keep the manual in a safe and accessible place for future reference.

## WARNING

### To prevent injury or fire, take the following precautions:

- To prevent a short circuit, never put or leave any metallic objects (such as coins or metallic tools) inside the unit.
- Do not watch or fix your eyes on the unit's display when you are driving for any extended period.
- Do not operate the unit while driving. If you need to operate the unit while driving, be sure to look around carefully.
- Do not attempt to install or service this product by yourself. Installation or servicing of this product by persons without training and experience in electronic equipment and automotive accessories may be dangerous and could expose you to the risk of electric shock, injury or other hazards.
- Do not allow this product to come into contact with liquids. Electrical shock could result. Also, damage to the product, smoke, and overheating could result from contact with liquids.
- If liquid or foreign matter should get inside this product, stop your vehicle in a safe place, turn the ignition switch off (ACC OFF) immediately and consult your dealer or the nearest authorized Toyota Service Station. Do not use this product in this condition because doing so may result in a fire, electric shock, or other failure.

## IMPORTANT SAFETY INFORMATION

- If you notice smoke, a strange noise or odor from this product, or any other abnormal signs on the LCD screen, turn off the power immediately and consult your dealer or the nearest authorized Toyota Service Station. Using this product in this condition may result in permanent damage to the system.
- Do not disassemble or modify this product, as there are high-voltage components inside which may cause an electric shock. Be sure to consult your dealer or the nearest authorized Toyota Service Station for internal inspection, adjustments or repairs.

## BEFORE USE

### ■ Before removing the vehicle battery

The information is erased by disconnecting the power cable from the battery (or removing the battery itself). Some of the settings and recorded contents will not be reset.

### ■ Cleaning the unit

If the faceplate of this unit is stained, wipe it with a dry soft cloth such as a silicon cloth. If the faceplate is stained badly, wipe it with a cloth moistened with neutral cleaner, then wipe it again with a clean soft dry cloth.

#### NOTE

Applying spray cleaner directly to the unit may damage its mechanical parts. Wiping the faceplate with a hard cloth or using a volatile liquid such as thinner or alcohol may scratch the surface or erase the screened print.

### ■ Protecting the monitor

- To protect the monitor from damage, do not operate the monitor using a ball point pen or similar tool with a sharp tip.
- If you stick a film screen protector on the screen, it may interfere with touch panel operation.

### ■ Touch panel

- The sensitivity of the touch panel decreases if a screen protector is installed.
- The buttons illumination and display illumination automatically dim when the car's headlights are turned on or when the vehicle sensor detected the surrounding light levels are low.  
If you turn on the car's headlights or when the vehicle sensor detected the surrounding light levels are low when the unit is turned off, the buttons illumination automatically dim.
- Direct sunlight may affect the visibility of the display window and its contents.
- Reflection may be occurred which caused by the polished display.

### ■ Lens fogging

When you turn on the car heater in cold weather, dew may form on the lens in the disc player of the unit due to condensation. This condensation on the lens (also called lens fogging) may not allow discs to play. In such a situation, remove the disc and wait for the dew to evaporate.

## BEFORE USE

### ■ Precautions on handling discs

- Do not touch the recording surface of the disc.
- Do not stick tape etc. on the disc, or use a disc with tape stuck on it.
- Do not use disc type accessories.
- Clean the disc from the center toward the outside rim.
- When removing a disc from this unit, pull it out horizontally.
- If the disc center hole or outside rim has burrs, use the disc only after removing the burrs with a ballpoint pen etc.
- Discs that are not round cannot be used.

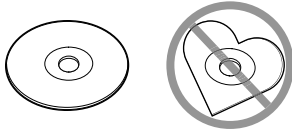

- 8-cm (3 inch) discs cannot be used.
- Discs with coloring on the recording surface or discs that are dirty cannot be used.
- This unit can only play the following types of CDs.



- This unit may not correctly play discs which do not have the mark.
- You cannot play a disc that has not been finalized. (For the finalization process, see your writing software and your recorder's instruction manual.)

### ■ About radio band

- You can register AM/FM radio frequencies to the preset buttons which allows to recall the registered station easily.

### ■ About USB devices

- This unit cannot support a USB device connected via a USB hub.
- Connecting a cable whose total length is longer than 5 m may result in abnormal playback.
- This unit cannot recognize a USB device whose rating is other than 5 V and exceeds 1.0 A.

### ■ About iPod/iPhone

- The models which have the Lightning port can be connected to this unit.
- Depending on the version of the operating system of the iPod/iPhone, some functions may not operate on this unit.

### ■ About Bluetooth

- Depending on the Bluetooth version of the device, some Bluetooth devices may not be able to connect to this unit.
- Signal conditions vary, depending on the surroundings.

# BASIC OPERATIONS

## Buttons overview

### 2Din CD Premium Audio (Models with Bluetooth features)

Left-hand drive model:

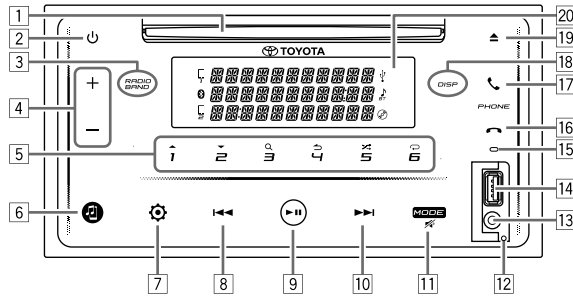



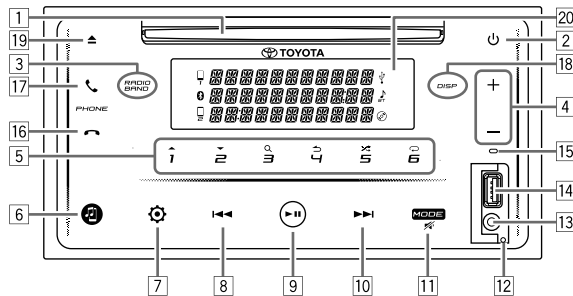



Right-hand drive model:



No.	Part	Operation	Function
1	Disc loading slot		Insert a disc.
2	⏻	To turn on/off the power	Touch the button to turn on the power. (When the ignition switch is in ON or ACC only.) • Touch and hold the button to turn off the power.
3	<b>RADIO BAND</b>	To select RADIO source To select radio band	Touch the button to select RADIO source. Touch the button to select radio band (FM1/FM2/AM) while in RADIO source.
4	+ / -	To adjust the volume	Touch button + or button - to adjust the volume. • Touch and hold button + to continuously increases the volume to 25.
5	<b>1 to 6</b>	To enter number selection	Touch button <b>1</b> to <b>6</b> to enter number selection directly.
	<b>1▲/2▼</b>	To make selection	Touch the button to make selection.
	<b>3🔍</b>	To enter search mode	Touch the button to enter search mode.
	<b>4↶</b>	To return to previous setting item	Touch the button to return to previous setting item.
	<b>5🔀</b>	To select random playback mode	Touch the button to select random playback mode.
	<b>6🔁</b>	To select repeat playback mode	Touch the button to select repeat playback mode.
6	📶	To select BT AUDIO source	Touch the button to select BT AUDIO source.
7	⚙️	To enter [FUNCTION] menu	Touch the button to enter [FUNCTION] menu.

## BASIC OPERATIONS

No.	Part	Operation	Function
8		To select an item or move to left position	Touch the button to select an item or to move to left position.
		To reverse	Touch and hold the button to reverse a track/file.
		To search for a RADIO station	Touch the button to search for a station manually while in RADIO source. • Touch and hold the button to search for a station automatically.
9		To play or pause	Touch the button to play or pause a track/file.
		To confirm selection	Touch the button to confirm the selection.
10		To select an item or move to right position	Touch the button to select an item or to move to right position.
		To fast-forward	Touch and hold the button to fast-forward a track/file.
		To search for a RADIO station	Touch the button to search for a station manually while in RADIO source. • Touch and hold the button to search for a station automatically.
11	<b>MODE</b> 	To select a playback source	Touch the button repeatedly to select your desired playback source.
		To mute the sound	Touch and hold the button to mute the sound. • Touch and hold again to restore the previous volume.
12	Reset button	To reset the unit	Press using a sharp object to reset the unit. • Your preset adjustments will also be erased except stored radio stations.
13	Auxiliary input jack		Connect a portable audio player.
14	USB input terminal		Connect a USB device.
15	Built-in microphone		Speak via Bluetooth hands-free mode when a Bluetooth phone is connected.
			Speak the name of the contact you want to call or the voice command to control the phone functions when a Bluetooth phone is connected and <b>[VOICE CONTROL]</b> is activated.
16		To end or reject a call	Touch the button to end or reject a call when a Bluetooth phone is connected.
17		To answer a call	Touch the button to answer a call when a Bluetooth phone is connected.
18	<b>DISP</b>	To turn off illumination	Touch the button to turn off all the illumination on the touch panel. • See also "How to turn on the illumination on the touch panel" on page 9.
19		To eject a disc	Touch the button to eject a disc.
20	Display window		Display the playback information or settings you made.

# BASIC OPERATIONS

## 2Din CD Basic Audio (Models without Bluetooth features)

Left-hand drive model:

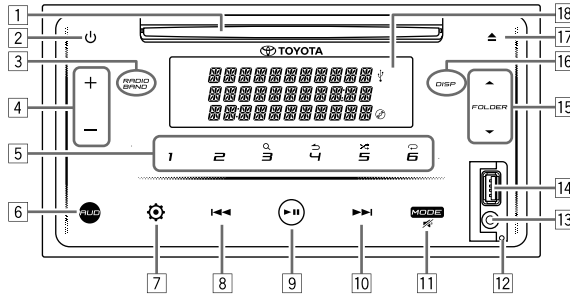



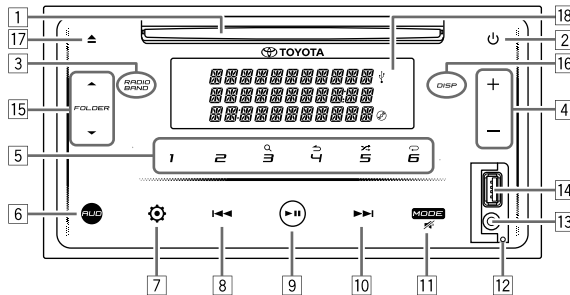



Right-hand drive model:



No.	Part	Operation	Function
1	Disc loading slot		Insert a disc.
2	⏻	To turn on/off the power	Touch the button to turn on the power. (When the ignition switch is in ON or ACC only.) • Touch and hold the button to turn off the power.
3	<b>RADIO BAND</b>	To select RADIO source To select radio band	Touch the button to select RADIO source. Touch the button to select radio band (FM1/FM2/AM) while in RADIO source.
4	+ / -	To adjust the volume	Touch button + or button - to adjust the volume. • Touch and hold the button + to continuously increases the volume to 25.
5	<b>1 to 6</b>	To enter number selection	Touch button <b>1</b> to <b>6</b> to enter number selection directly.
	<b>3</b> 🔍	To enter search mode	Touch the button to enter search mode.
	<b>4</b> ↶	To return to previous setting item	Touch the button to return to previous setting item.
	<b>5</b> 🎲	To select random playback mode	Touch the button to select random playback mode.
	<b>6</b> 🔄	To select repeat playback mode	Touch the button to select repeat playback mode.
6	<b>AUD</b>	To enter [AUDIO CONTROL] menu	Touch the button to enter [AUDIO CONTROL] menu.
7	⚙️	To enter [FUNCTION] menu	Touch the button to enter [FUNCTION] menu.

## BASIC OPERATIONS

No.	Part	Operation	Function
8		To select an item or move to left position	Touch the button to select an item or move to left position.
		To reverse	Touch and hold the button to reverse a track/file.
		To search for a RADIO station	Touch the button to search for a station manually while in RADIO source. • Touch and hold the button to search for a station automatically.
9		To play or pause	Touch the button to play or pause a track/file.
		To confirm selection	Touch the button to confirm the selection.
10		To select an item or move to right position	Touch the button to select an item or move to right position.
		To fast-forward	Touch and hold the button to fast-forward a track/file.
		To search for a RADIO station	Touch the button to search for a station manually while in RADIO source. • Touch and hold the button to search for a station automatically.
11	<b>MODE</b> 	To select a playback source	Touch the button repeatedly to select your desired playback source.
		To mute the sound	Touch and hold the button to mute the sound. • Touch and hold again to restore the previous volume.
12	Reset button	To reset the unit	Press using a sharp object to reset the unit. • Your preset adjustments will also be erased except stored radio stations.
13	Auxiliary input jack		Connect a portable audio player.
14	USB input terminal		Connect a USB device.
15	<b>FOLDER</b>  / <b>FOLDER</b> 	To make selection	Touch the button to make selection.
16	<b>DISP</b>	To turn off illumination	Touch the button to turn off all the illumination on the touch panel. • See also "How to turn on the illumination on the touch panel!" on page 9.
17		To eject a disc	Touch the button to eject a disc.
18	Display window		Display the playback information or settings you made.



## BASIC OPERATIONS

### How to turn on the illumination on the touch panel

Touch any button on the touch panel to turn on the illumination. (Available for all models.)

#### 2Din CD Premium Audio (Models with Bluetooth features)

Left-hand drive model:

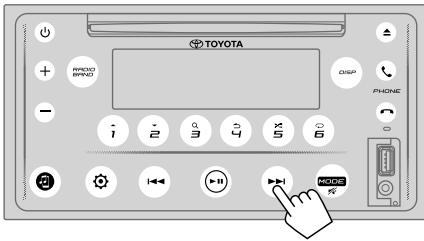

Right-hand drive model:

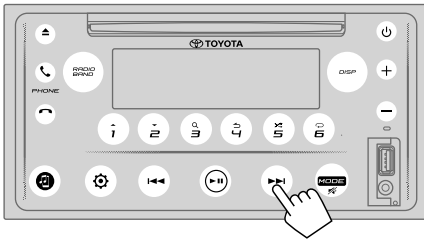

#### 2Din CD Basic Audio (Models without Bluetooth features)

Left-hand drive model:

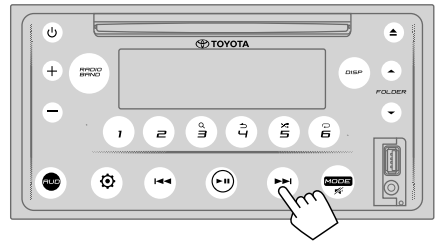

Right-hand drive model:

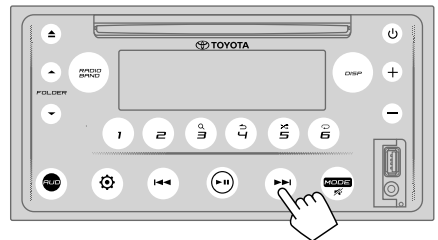

While the illumination is off...

- The illumination on the touch panel turn on automatically for 5 seconds when a disc is inserted or a USB device is plugged-in.
- The illumination on the touch panel turn on automatically while receiving signals from FM broadcast and turn off automatically when ended.
- The illumination on the touch panel turn on automatically while calling, receiving calls or talking via Bluetooth hands-free mode and turn off automatically when the conversation ended.
- When using remote control or steering switch to operate, the illumination on the touch panel turn on for 5 seconds and turn off automatically except for volume buttons.

## BASIC OPERATIONS

### Remote control

This unit can be operated using the remote control.  
Note: Remote Control is optional which may not be supplied in some vehicles.

### ▲ WARNING

- Do not ingest the battery, Chemical Burn Hazard  
The remote control supplied with this product contains a coin / button cell battery. If the coin / button cell battery is swallowed, it can cause severe internal burns in just 2 hours and can lead to death. Keep new and used batteries away from children. If the battery compartment does not close securely, stop using the product and keep it away from children. If you think batteries might have been swallowed or placed inside any part of the body, seek immediate medical attention.

### ▲ CAUTION

- Put the remote control in a place where it will not move during braking or other operations.  
A dangerous situation could result, if the remote control falls down and gets wedged under the pedals while driving.
- Do not leave the battery near fire or under direct sunlight. A fire, explosion or excessive heat generation may result.
- Do not recharge, short, break up or heat the battery or place it in an open fire. Such actions may cause the battery to leak fluid. If spilled fluid comes in contact with your eyes or on clothing, immediately rinse with water and consult a physician.
- Danger of explosion if Lithium battery is incorrectly replaced. Replace only with the same or equivalent type.

### ■ Using the remote control

Point the remote control in the direction of the touch panel to operate.

- The remote control may not function properly in direct sunlight.

### IMPORTANT

- Do not store the remote control in high temperatures or direct sunlight.
- Do not let the remote control fall onto the floor, where it may become jammed under the brake or accelerator pedal.

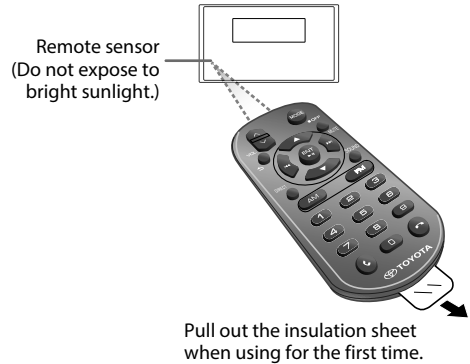

### How to replace the battery

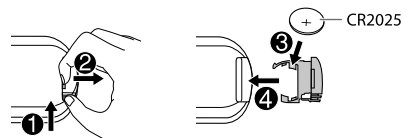

# BASIC OPERATIONS

## Buttons overview

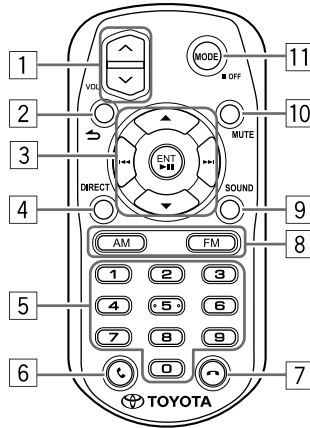

No.	Part	Operation	Function
1	<b>VOL</b> ^ / <b>VOL</b> v	To adjust the volume	Press <b>VOL</b> ^ or <b>VOL</b> v to adjust the volume. • Press and hold <b>VOL</b> ^ to continuously increase the volume to 25.
2	↶	To return to previous setting item	Press the button to return to previous setting item.
3	<b>ENT</b> ►	To play or pause	Press the button to play or pause a track/file.
		To confirm selection	Press the button to confirm the selection.
	◀◀ / ▶▶	To select an item	Press the button to select an item.
		To reverse or fast-forward	Press and hold the button to reverse or fast-forward a track/file.
		To search for a RADIO station	• Press and hold the button to search for a station automatically while in RADIO source. • Press the button to select a preset station while in RADIO source.
	▲ / ▼	To make selection	Press the button to make selection.
4	<b>DIRECT</b>	To enter Direct Access Tuning / Direct Music Search	Press the button to enter Direct Access Tuning / Direct Music Search.
5	<b>0</b> to <b>9</b>	To enter number selection	Press the button to enter number selection directly.
		To enter preset station number	Press the button <b>1</b> to <b>6</b> to enter preset station number.
6	☎	To answer a call	Press the button to answer a call when a Bluetooth phone is connected.
7	☎	To end or reject a call	Press the button to end or reject a call when a Bluetooth phone is connected.
8	<b>AM</b> / <b>FM</b>	To select FM / AM band	Press the button to select FM1/FM2/AM band.

## BASIC OPERATIONS

No.	Part	Operation	Function
9	<b>SOUND</b>	To enter [AUDIO CONTROL] menu	Press the button to enter [AUDIO CONTROL] menu.
10	<b>MUTE</b>	To mute the sound	Press the button to mute the sound. • Press the button again to restore the previous volume.
11	<b>MODE</b>	To turn on/off the power	Press the button to turn on the power. (When the ignition switch is in ON or ACC only.) • Press and hold the button to turn off the power.
		To select a playback source	Press the button repeatedly to select your desired playback source. (When the power is on.)

### Operations using the steering switch

- This unit can be operated using the steering switch.
- Steering wheel control function is varied depends on vehicle and vehicle grade.

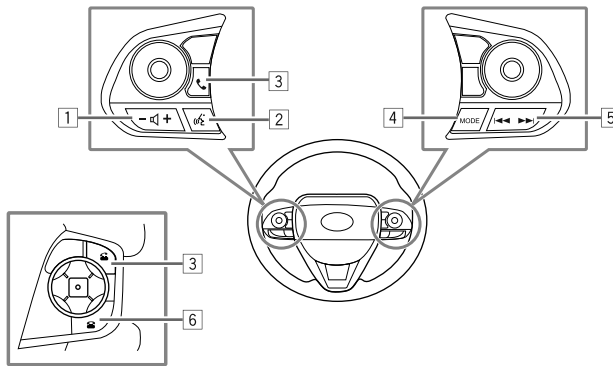

No.	Part	Operation	Function	2Din CD Audio	
				Basic	Premium
1	🔊 +/-	To adjust the volume	Press +/- to adjust the volume. • Press and hold + to continuously increase the volume to 25. • Press and hold - to continuously decrease the volume.	Available	Available
2	🗣️	To start or end voice recognition	When a Bluetooth phone is connected... • Press to start voice recognition. • Press and hold to end voice recognition.	Not available	Available
3	📞	To answer a call	When there is an incoming call... • Press to answer a call. • Press and hold to reject a call.  While talking... • Press to put on hold or release the current call. • Press and hold to end a call.  While talking on the first incoming call... • Press to hold the current call and answer another incoming call.  While dialing... • Press and hold to cancel a call.	Not available	Available

## BASIC OPERATIONS

No.	Part	Operation	Function	2Din CD Audio	
				Basic	Premium
4	<b>MODE</b>	To select a playback source	Press the button repeatedly to select your desired playback source.	Available	Available
		To mute the sound	Press and hold the button to mute the sound. • Press and hold again to restore the previous volume.	Available	Available
5	◀◀/▶▶	To reverse or fast-forward	Press the button to forward/reverse select the track, file or chapter.	Available	Available
		To search for a RADIO station	• Press and hold the button to search for a radio station automatically while in RADIO source. • Press the button to select a preset station while in RADIO source.	Available	Available
6		To end or reject a call	When there is an incoming call... • Press to reject a call.	Not available	Available
			While talking... • Press to end a call.		
			While dialing... • Press to cancel a call.		

The functions and appearance vary depending on the car model.

### Note

- Voice Recognition button will work depends on the phone settings when mobile device is connected via Bluetooth. If the command is recognised by the connected Bluetooth device, it will operate according to the voice command. Voice Recognition is for call purpose only.

# BASIC SETTINGS

## 2Din CD Premium Audio (Models with Bluetooth features)

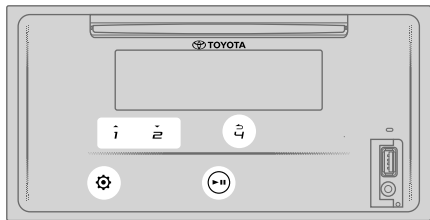

## 2Din CD Basic Audio (Models without Bluetooth features)

Left-hand drive model:

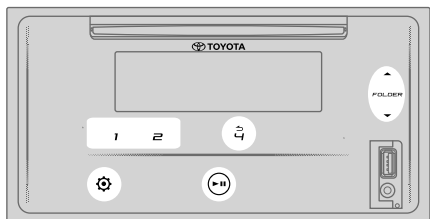

Right-hand drive model:

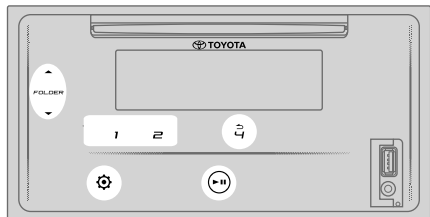

## Clock settings

### Set the clock

- 1 Touch to enter [FUNCTION].
- 2 Touch 1 / 2 or FOLDER / FOLDER to select [CLOCK SETTING], then touch .
- 3 Touch 1 / 2 or FOLDER / FOLDER to select [TIME SET], then touch .
- 4 Touch 1 / 2 or FOLDER / FOLDER to set the hour, then touch to confirm.
- 5 Touch 1 / 2 or FOLDER / FOLDER to set the minute, then touch to confirm.
- 6 Touch 1 / 2 or FOLDER / FOLDER to select [TIME FORMAT], then touch .
- 7 Touch 1 / 2 or FOLDER / FOLDER to select [12H] or [24H], then touch to confirm.
- 8 Touch to exit.

To return to the previous setting item, touch 4 .

### Set the time display



- 1 Touch to enter [FUNCTION].
- 2 Touch 1 / 2 or FOLDER / FOLDER to select [CLOCK SETTING], then touch .
- 3 Touch 1 / 2 or FOLDER / FOLDER to select [TIME DISPLAY], then touch .
- 4 Touch 1 / 2 or FOLDER / FOLDER to select [ON] (default) to turn on the clock display on all sources.  
(or)  
Touch 1 / 2 or FOLDER / FOLDER to select [OFF] to turn off the clock display on all sources.
- 5 Touch to confirm.
- 6 Touch to exit.

To return to the previous setting item, touch 4 .

## BASIC SETTINGS



### System settings

#### ■ Set the keytouch tone

- 1 Touch  to enter [FUNCTION].
- 2 Touch 1▲ / 2▼ or FOLDER ▲ / FOLDER ▼ to select [SYSTEM SETTING], then touch ► **II**.
- 3 Touch 1▲ / 2▼ or FOLDER ▲ / FOLDER ▼ to select [KEY BEEP], then touch ► **II**.
- 4 Touch 1▲ / 2▼ or FOLDER ▲ / FOLDER ▼ to select [ON] or [OFF].  
[ON] (default): Activates the keytouch tone.  
[OFF]: Deactivates the keytouch tone.
- 5 Touch ► **II** to confirm.
- 6 Touch  to exit.

To return to the previous setting item, touch 4 ➡.



#### ■ Select the language

- 1 Touch  to enter [FUNCTION].
- 2 Touch 1▲ / 2▼ or FOLDER ▲ / FOLDER ▼ to select [SYSTEM SETTING], then touch ► **II**.
- 3 Touch 1▲ / 2▼ or FOLDER ▲ / FOLDER ▼ to select [LANGUAGE SELECT], then touch ► **II**.
- 4 Touch 1▲ / 2▼ or FOLDER ▲ / FOLDER ▼ to select the below display language for [FUNCTION] menu and music information if applicable.  
[ENGLISH] (default) / [PORTUGUES] / [BAHASA INDONESIA] / [BAHASA MALAYSIA] / [ESPAÑOL]
- 5 Touch ► **II** to confirm.
- 6 Touch  to exit.

To return to the previous setting item, touch 4 ➡.



### Audio settings

#### ■ Select a preset equalizer

- 1 Touch  to enter [FUNCTION].
  - For 2Din CD Basic Audio, touching **AUD** enters [AUDIO CONTROL] menu directly.
- 2 Touch 1▲ / 2▼ or FOLDER ▲ / FOLDER ▼ to select [AUDIO CONTROL], then touch ► **II**.
- 3 Touch 1▲ / 2▼ or FOLDER ▲ / FOLDER ▼ to select [PRESET EQ], then touch ► **II**.
- 4 Touch 1▲ / 2▼ or FOLDER ▲ / FOLDER ▼ to select a preset equalizer suitable to the music genre, then touch ► **II** to confirm.  
[FLAT] (default) / [POP] / [R&B] / [JAZZ] / [CLASSICAL] / [HARD ROCK] / [C-SUV H/B] / [SEDAN] / [MPV] / [SUV PU] / [VAN] / [USER]
  - Select [USER] to use the settings made in [MANUAL EQ].
  - The [PRESET EQ] is optimized for each vehicle type (Sedan / C-SUV, compact SUV / H/B, Hatchback / MPV / SUV PU, Pick Up Truck / Van) and produce clean, distortion-free natural sound at any listening level.
- 5 Touch  to exit.

To return to the previous setting item, touch 4 ➡.



#### ■ Adjust the bass boost

- 1 Touch  to enter [FUNCTION].
  - For 2Din CD Basic Audio, touching **AUD** enters [AUDIO CONTROL] menu directly.
- 2 Touch 1▲ / 2▼ or FOLDER ▲ / FOLDER ▼ to select [AUDIO CONTROL], then touch ► **II**.
- 3 Touch 1▲ / 2▼ or FOLDER ▲ / FOLDER ▼ to select [BASS BOOST], then touch ► **II**.
- 4 Touch 1▲ / 2▼ or FOLDER ▲ / FOLDER ▼ to select your preferred bass boost level ([LEVEL1] to [LEVEL5]), or select [OFF] (default) to cancel.
- 5 Touch ► **II** to confirm.
- 6 Touch  to exit.

To return to the previous setting item, touch 4 ➡.



## BASIC SETTINGS

### Adjust the rear and front speaker output balance

- 1 Touch  to enter [FUNCTION].
  - For 2Din CD Basic Audio, touching **AUD** enters [AUDIO CONTROL] menu directly.
- 2 Touch **1 ▲ / 2 ▼** or **FOLDER ▲ / FOLDER ▼** to select [AUDIO CONTROL], then touch **▶ II**.
- 3 Touch **1 ▲ / 2 ▼** or **FOLDER ▲ / FOLDER ▼** to select [FADER SETTING], then touch **▶ II**.
- 4 Touch **1 ▲ / 2 ▼** or **FOLDER ▲ / FOLDER ▼** to adjust the setting, then touch **▶ II** to confirm.  
[POS R15] to [POS F15] (default: [POS 0])
- 5 Touch  to exit.

To return to the previous setting item, touch **4 ↵**.

### Adjust the left and right speaker output balance

- 1 Touch  to enter [FUNCTION].
  - For 2Din CD Basic Audio, touching **AUD** enters [AUDIO CONTROL] menu directly.
- 2 Touch **1 ▲ / 2 ▼** or **FOLDER ▲ / FOLDER ▼** to select [AUDIO CONTROL], then touch **▶ II**.
- 3 Touch **1 ▲ / 2 ▼** or **FOLDER ▲ / FOLDER ▼** to select [BALANCE SETTING], then touch **▶ II**.
- 4 Touch **1 ▲ / 2 ▼** or **FOLDER ▲ / FOLDER ▼** to adjust the setting, then touch **▶ II** to confirm.  
[POS L15] to [POS R15] (default: [POS 0])
- 5 Touch  to exit.

To return to the previous setting item, touch **4 ↵**.

### Adjust the sound effect settings



- 1 Touch  to enter [FUNCTION].
  - For 2Din CD Basic Audio, touching **AUD** enters [AUDIO CONTROL] menu directly.
- 2 Touch **1 ▲ / 2 ▼** or **FOLDER ▲ / FOLDER ▼** to select [AUDIO CONTROL], then touch **▶ II**.
- 3 Touch **1 ▲ / 2 ▼** or **FOLDER ▲ / FOLDER ▼** to select [SOUND EFFECT], then touch **▶ II**.
- 4 Touch **1 ▲ / 2 ▼** or **FOLDER ▲ / FOLDER ▼** to select [K2 TECHNOLOGY], then touch **▶ II**.
- 5 Touch **1 ▲ / 2 ▼** or **FOLDER ▲ / FOLDER ▼** to select [ON] or [OFF].  
[ON] (default): Creates realistic sound by compensating the high-frequency components and restoring the rise-time of the waveform that are lost in audio data compression.  
[OFF]: Cancels.
  - Not applicable for RADIO source and AUX source.
- 6 Touch **▶ II** to confirm.
- 7 Touch **1 ▲ / 2 ▼** or **FOLDER ▲ / FOLDER ▼** to select [SPACE ENHANCEMENT], then touch **▶ II**.
- 8 Touch **1 ▲ / 2 ▼** or **FOLDER ▲ / FOLDER ▼** to make one of the following selection.  
[SMALL] / [MEDIUM] / [LARGE]: Virtually enhances the sound space.  
[OFF] (default): Cancels.
  - Not applicable for RADIO source.
- 9 Touch **▶ II** to confirm.

- 10 Touch **1 ▲ / 2 ▼** or **FOLDER ▲ / FOLDER ▼** to select [SOUND LIFT], then touch **▶ II**.
- 11 Touch **1 ▲ / 2 ▼** or **FOLDER ▲ / FOLDER ▼** to make one of the following selection.  
[LOW] / [MIDDLE] / [HIGH]: Virtually adjust the sound position heard from the speakers.  
[OFF] (default): Cancels.
- 12 Touch **▶ II** to confirm.
- 13 Touch **1 ▲ / 2 ▼** or **FOLDER ▲ / FOLDER ▼** to select [AUTO SOUND LEVEL], then touch **▶ II**.
- 14 Touch **1 ▲ / 2 ▼** or **FOLDER ▲ / FOLDER ▼** to select [ON] or [OFF].  
[ON] (default): Boosts the frequency to reduce the noise heard from outside the car or running noise of the tyres.  
[OFF]: Cancels.
- 15 Touch **▶ II** to confirm.
- 16 Touch  to exit.

To return to the previous setting item, touch **4 ↵**.

### Adjust the equalizer manually

Before making an adjustment, select the source you want to adjust.

- 1 Touch  to enter [FUNCTION].
  - For 2Din CD Basic Audio, touching **AUD** enters [AUDIO CONTROL] menu directly.
- 2 Touch **1 ▲ / 2 ▼** or **FOLDER ▲ / FOLDER ▼** to select [AUDIO CONTROL], then touch **▶ II**.
- 3 Touch **1 ▲ / 2 ▼** or **FOLDER ▲ / FOLDER ▼** to select [PRO MODE], then touch **▶ II**.
- 4 Touch **1 ▲ / 2 ▼** or **FOLDER ▲ / FOLDER ▼** to select [MANUAL EQ], then touch **▶ II**.
  - The sound elements (frequency level, tone level, Q factor) are preset into each selection.
- 5 Touch **1 ▲ / 2 ▼** or **FOLDER ▲ / FOLDER ▼** to select a frequency you want to adjust, then touch **▶ II**.  
[62.5HZ] / [100HZ] / [160HZ] / [250HZ] / [400HZ] / [630HZ] / [1KHZ] / [1.6KHZ] / [2.5KHZ] / [4KHZ] / [6.3KHZ] / [10KHZ] / [16KHZ]
- 6 Touch **1 ▲ / 2 ▼** or **FOLDER ▲ / FOLDER ▼** to adjust the level to memorize for each source, then touch **▶ II** to confirm.  
[LEVEL -9] to [LEVEL +9], (default: [LEVEL 0])
- 7 Touch **1 ▲ / 2 ▼** or **FOLDER ▲ / FOLDER ▼** to select [Q FACTOR SETTING] to adjust the quality factor, then touch **▶ II** to confirm.  
[1.35] / [1.50] (default) / [2.00]
- 8 Touch  to exit.

To return to the previous setting item, touch **4 ↵**.





## BASIC SETTINGS

### ■ Set the digital time alignment

Digital Time Alignment sets the delay time of the speaker output to create a more suitable environment for your vehicle.

- For more information, ➔ **Determining the value for [DISTANCE] and [GAIN] of [DTA SETTINGS].**

- 1 Touch  to enter [FUNCTION].
  - For 2Din CD Basic Audio, touching **AUD** enters [AUDIO CONTROL] menu directly.
- 2 Touch **1▲ / 2▼** or **FOLDER ▲ / FOLDER ▼** to select [AUDIO CONTROL], then touch **▶ II**.
- 3 Touch **1▲ / 2▼** or **FOLDER ▲ / FOLDER ▼** to select [PRO MODE], then touch **▶ II**.
- 4 Touch **1▲ / 2▼** or **FOLDER ▲ / FOLDER ▼** to select [DTA SETTINGS], then touch **▶ II**.
- 5 Touch **1▲ / 2▼** or **FOLDER ▲ / FOLDER ▼** to select [POSITION], then touch **▶ II**.
- 6 Touch **1▲ / 2▼** or **FOLDER ▲ / FOLDER ▼** to select your listening position (reference point), then touch **▶ II** to confirm.  
[ALL] (default): Not compensating;  
[FRONT RIGHT]: Front right seat;  
[FRONT LEFT]: Front left seat;  
[FRONT ALL]: Front seat
- 7 Touch **1▲ / 2▼** or **FOLDER ▲ / FOLDER ▼** to select [DISTANCE], then touch **▶ II**.
- 8 Touch **1▲ / 2▼** or **FOLDER ▲ / FOLDER ▼** to fine adjust the distance to compensate, then touch **▶ II** to confirm.  
[OCM] (default) to [610CM]
  - Before making adjustment, select the speaker you want to adjust.
- 9 Touch **1▲ / 2▼** or **FOLDER ▲ / FOLDER ▼** to select [GAIN], then touch **▶ II**.
- 10 Touch **1▲ / 2▼** or **FOLDER ▲ / FOLDER ▼** to fine adjust the output volume of the selected speaker, then touch **▶ II** to confirm.  
[-8DM] to [0DB] (default)
  - Before making adjustment, select the speaker you want to adjust.
- 11 Touch **1▲ / 2▼** or **FOLDER ▲ / FOLDER ▼** to select [INITIALIZE SETTINGS], then touch **▶ II**.
- 12 Touch **1▲ / 2▼** or **FOLDER ▲ / FOLDER ▼** to select [YES] or [NO].  
[YES]: Resets the settings ([DISTANCE] and [GAIN]) of the selected position to default.  
[NO] (default): Cancels.
- 13 Touch **▶ II** to confirm.
- 14 Touch  to exit.

- Before making an adjustment for [DISTANCE] and [GAIN] of [DTA SETTINGS], select the speaker you want to adjust: [FRONT LEFT] / [FRONT RIGHT] / [REAR LEFT] / [REAR RIGHT]

To return to the previous setting item, touch **4↩**.

### Determining the value for [DISTANCE] and [GAIN] of [DTA SETTINGS]

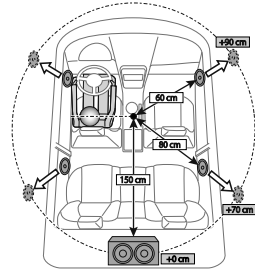

If you specify the distance from the center of the currently set listening position to every speaker, the delay time will be automatically computed and set.

- 1 Determine the center of the currently set listening position as the reference point.
- 2 Measure the distances from the reference point to the speakers.
- 3 Calculate the differences between the distance of the furthest speaker (rear speaker) and other speakers.
- 4 Set the [DISTANCE] calculated in step 3 for individual speakers.
- 5 Adjust [GAIN] for individual speakers.

Example: When [FRONT ALL] is selected as the listening position

## BASIC SETTINGS

### Display settings

#### Adjust the brightness

- 1 Touch to enter [FUNCTION].
- 2 Touch 1▲ / 2▼ or FOLDER ▲ / FOLDER ▼ to select [DISPLAY SETTING], then touch ►||.
- 3 Touch 1▲ / 2▼ or FOLDER ▲ / FOLDER ▼ to select [BRTNESS LEVEL], then touch ►||.
- 4 Touch 1▲ / 2▼ or FOLDER ▲ / FOLDER ▼ to select your preferred brightness level for display illumination and button illumination, then touch ►|| to confirm. [LEVEL 0] to [LEVEL 31]
  - The buttons illumination and display illumination automatically dim when the car's headlights are turned on or when the vehicle sensor detected the surrounding light levels are low. If you turn on the car's headlights or when the vehicle sensor detected the surrounding light levels are low when the unit is turned off, the buttons illumination automatically dim.
- 5 Touch to exit.

To return to the previous setting item, touch 4↶.

#### Set text scrolling style

- 1 Touch to enter [FUNCTION].
- 2 Touch 1▲ / 2▼ or FOLDER ▲ / FOLDER ▼ to select [DISPLAY SETTING], then touch ►||.
- 3 Touch 1▲ / 2▼ or FOLDER ▲ / FOLDER ▼ to select [TEXT SCROLL], then touch ►||.
- 4 Touch 1▲ / 2▼ or FOLDER ▲ / FOLDER ▼ to select your preferred display information scrolling style, then touch ►|| to confirm.  
[AUTO]: The display information scroll automatically.  
[ONCE] (default): The display information scroll only once.  
[OFF]: Cancels.
- 5 Touch to exit.

To return to the previous setting item, touch 4↶.

#### Select illumination color

- 1 Touch to enter [FUNCTION].
- 2 Touch 1▲ / 2▼ or FOLDER ▲ / FOLDER ▼ to select [DISPLAY SETTING], then touch ►||.
- 3 Touch 1▲ / 2▼ or FOLDER ▲ / FOLDER ▼ to select [COLOR SELECT], then touch ►||.
- 4 Touch 1▲ / 2▼ or FOLDER ▲ / FOLDER ▼ to select your preferred illumination color, then touch ►|| to confirm.  
[INITIAL COLOR] (default) / [VARIABLE SCAN] / [CUSTOM R/G/B] / preset colors\*  
\* [RED1] / [RED2] / [RED3] / [PURPLE1] / [PURPLE2] / [PURPLE3] / [BLUE1] / [BLUE2] / [SKYBLUE1] / [SKYBLUE2] / [LIGHTBLUE] / [AQUA1] / [AQUA2] / [GREEN1] / [GREEN2] / [GREEN3] / [YELLOWGREEN1] / [YELLOWGREEN2] / [YELLOW] / [ORANGE1] / [ORANGE2] / [ORANGERED]
  - Avoid setting the color tone which is equivalent to the LCD screen backlight as this may cause low visibility and also danger while driving.
- 5 Touch to exit.

To return to the previous setting item, touch 4↶.

#### Make your own color

- 1 Touch to enter [FUNCTION].
- 2 Touch 1▲ / 2▼ or FOLDER ▲ / FOLDER ▼ to select [DISPLAY SETTING], then touch ►||.
- 3 Touch 1▲ / 2▼ or FOLDER ▲ / FOLDER ▼ to select [COLOR SELECT], then touch ►||.
- 4 Touch 1▲ / 2▼ or FOLDER ▲ / FOLDER ▼ to select [CUSTOM R/G/B] to make your own color.
  - The color you have made will be stored in [CUSTOM R/G/B].
  - Avoid setting the color tone which is equivalent to the LCD screen backlight as this may cause low visibility and also danger while driving.
- 5 Touch ►|| to enter the detailed color adjustment.
- 6 Touch ◀◀ / ▶▶ to select the color (R/G/B) to adjust.
- 7 Touch 1▲ / 2▼ or FOLDER ▲ / FOLDER ▼ to adjust the level (0 to 9), then touch ►|| to confirm.
- 8 Touch to exit.

To return to the previous setting item, touch 4↶.

#### Select display information

- 1 Touch to enter [FUNCTION].
- 2 Touch 1▲ / 2▼ or FOLDER ▲ / FOLDER ▼ to select [DISPLAY SETTING], then touch ►||.
- 3 Touch 1▲ / 2▼ or FOLDER ▲ / FOLDER ▼ to select [DISPLAY MODE], then touch ►||.
- 4 Touch 1▲ / 2▼ or FOLDER ▲ / FOLDER ▼ to select your preferred display information for the following playback source, then touch ►|| to confirm.
  - USB SOURCE or CD MEDIA SOURCE:  
[TITLE ALBUM] (default) / [FILENAME FOLDER] / [PLAY TIME] / [TITLE ARTIST]
  - IPOD SOURCE or BT AUDIO SOURCE:  
[TITLE ALBUM] (default) / [PLAY TIME] / [TITLE ARTIST]
  - CDDA SOURCE:  
[TRK TITLE DISC] (default) / [PLAY TIME] / [TRK TITLE ARTIST]
- 5 Touch to exit.

To return to the previous setting item, touch 4↶.

# RADIO

## 2Din CD Premium Audio (Models with Bluetooth features)

Left-hand drive model:

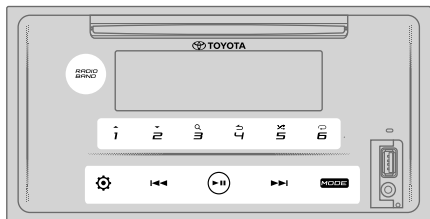

Right-hand drive model:

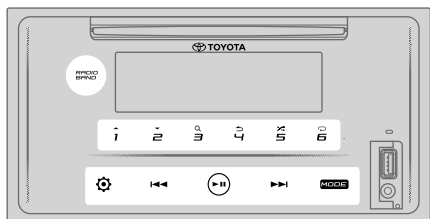

## 2Din CD Basic Audio (Models without Bluetooth features)

Left-hand drive model:

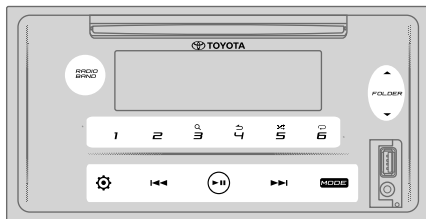

Right-hand drive model:

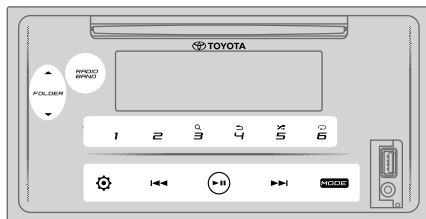

### Search for a station

- 1 Touch **MODE** repeatedly to select RADIO (or press **MODE** repeatedly on the remote control).
    - While in other sources than RADIO, touching **RADIO BAND** enters RADIO directly.
  - 2 Touch **RADIO BAND** repeatedly (or press **FM/AM** on the remote control) to select FM1/FM2/AM.
  - 3 Touch **◀◀** / **▶▶** to search for a station manually.  
(or)  
Touch and hold **◀◀** / **▶▶** (or press and hold **◀◀** / **▶▶** on the remote control) to search for a station automatically.
- To store a station:  
Touch and hold one of the number buttons (1 to 6).
  - To select a stored station:  
Touch one of the number buttons (1 to 6) (or press one of the number buttons (1 to 6) on the remote control / press **◀◀** / **▶▶** on the remote control).

### Direct Access Tuning (using the remote control)

- 1 Press **DIRECT** to enter Direct Access Tuning.
  - 2 Press the number buttons to enter a frequency.
  - 3 Press **ENT ▶▶** to search for a station.
- To cancel, press **↶** or **DIRECT**.
  - If no operation is done for 10 seconds after step 2, Direct Access Tuning is automatically canceled.

### Other settings

- 1 Touch **⚙** to enter [FUNCTION].
- 2 Touch **1 ▲** / **2 ▼** or **FOLDER ▲** / **FOLDER ▼** to select [RADIO SETTING], then touch **▶▶**.
- 3 Touch **1 ▲** / **2 ▼** or **FOLDER ▲** / **FOLDER ▼** to select [AUTO PRESET], then touch **▶▶**.
- 4 Touch **1 ▲** / **2 ▼** or **FOLDER ▲** / **FOLDER ▼** to select [YES] or [NO].  
[YES]: Automatically starts memorizing 6 stations with good reception into the number buttons (1 to 6).  
[NO] (default): Cancels.
- 5 Touch **▶▶** to confirm.
- 6 Touch **1 ▲** / **2 ▼** or **FOLDER ▲** / **FOLDER ▼** to select [MONO SET], then touch **▶▶**.
- 7 Touch **1 ▲** / **2 ▼** or **FOLDER ▲** / **FOLDER ▼** to select [ON] or [OFF].  
[ON]: Improves the FM reception, but the stereo effect may be lost.  
[OFF] (default): Cancels.
- 8 Touch **▶▶** to confirm.
- 9 Touch **⚙** to exit.

To return to the previous setting item, touch **4 ↶**.

**2Din CD Premium Audio (Models with Bluetooth features)**

Left-hand drive model:

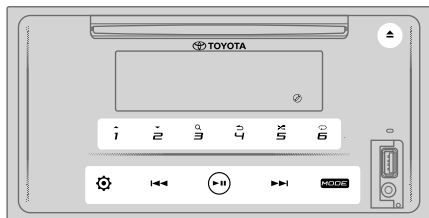

Right-hand drive model:

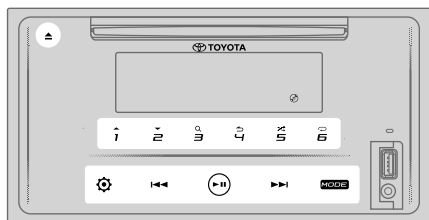
**2Din CD Basic Audio (Models without Bluetooth features)**

Left-hand drive model:

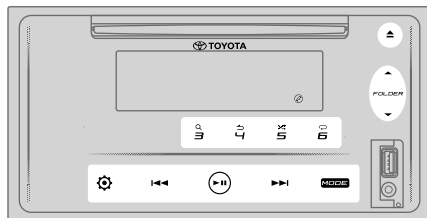

Right-hand drive model:

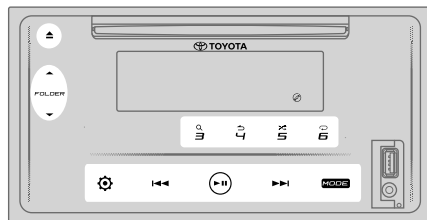
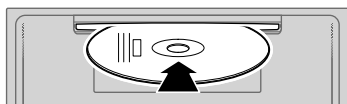
**Inserting a disc****Insert a disc into the disc loading slot.**

- The source changes to “CD” and playback starts automatically.
- “CD” indicator lights up on the display window when a disc is inserted.
- Track number and play time appear on the display window for a few seconds when a disc is inserted. Then, other disc information appear. See [DISPLAY MODE] on page 18 for more information.
- If a disc has already been inserted, touch **MODE** repeatedly (or press **MODE** repeatedly on the remote control) to select “CD” as the playback source.

**CAUTION**

- Do not insert anything other than a disc into the disc loading slot.

**Note**

- When the unit is turned off, disc cannot be removed from the unit.
- Insert only one disc into the disc loading slot at a time.
- Do not use discs with labels or stickers.

**Ejecting a disc**Touch **▲** to eject a disc.

Remove the disc from the disc loading slot.

**Pause playback**Touch **▶||** (or press **ENT ▶||** on the remote control) to pause the playback.

Play time will be displayed and blinking during pause.

**Track or file up/down**Touch **▶|** (or press **▶|** on the remote control) to go to the next track (or file).Touch **|◀◀** (or press **|◀◀** on the remote control) to go to the previous track or file.**Folder up/down**Touch **1 ▲** or **FOLDER ▲** to go to the next folder.Touch **2 ▼** or **FOLDER ▼** to go to the previous folder.**Note**

- This function is available only when the disc contains more than one folder.
- This function is not available for Audio CD.

### Selecting a track or file from the list

- 1 Touch **3Q** to display the list on the display window.
- 2 Touch **1▲ / 2▼** or **FOLDER ▲ / FOLDER ▼** to select your desired track or file.
- 3 Touch **▶||** to play the selected song.

To return to the previous setting item, touch **4↶**.

### Selecting a file from a folder

- 1 Touch **3Q** to display the list on the display window.
- 2 Touch **1▲ / 2▼** or **FOLDER ▲ / FOLDER ▼** to select your desired folder, then touch **▶||** to confirm.
- 3 Touch **1▲ / 2▼** or **FOLDER ▲ / FOLDER ▼** to select your desired file.
- 4 Touch **▶||** to play the selected song.

(or using the remote control)

- 1 Press **▲ / ▼** to display the list on the display window.
- 2 Press **▲ / ▼** to go to the next or previous folder.

- To return to the top menu, touch **5**.
- To return to the previous setting item, touch **4↶**.
- To cancel, touch and hold **4↶**.

#### Note

- This function is available only when the disc contains more than one folder.

### Direct Music Search (using the remote control)

- 1 Press **DIRECT**.
- 2 Press the number buttons to enter a track/file number.
- 3 Press **ENT ▶||** to search for music.

To cancel, press **↶** or **DIRECT**.

#### Note

- Not available if Random Play is selected.

### Fast-forward/Fast-reverse

Touch and hold **▶▶|** (or press and hold **▶▶|** on the remote control) to fast-forward.

Touch and hold **|◀◀** (or press and hold **|◀◀** on the remote control) to fast-reverse.

### Repeat play

Touch **6↻** repeatedly to select the repeat playback mode.

Audio CD:

- TRACK REPEAT:** Repeats the current track.
- ALL REPEAT:** Repeats all the tracks in the current disc.

MP3/WMA/AAC file:

- SONG REPEAT:** Repeats the current file.
- FOLDER REPEAT:** Repeats all the files in the current folder.
- ALL REPEAT:** Repeats all the files in the current disc.

### Random play

Touch **5↻** repeatedly to select the random playback mode.

Audio CD:

- DISC RANDOM:** Plays all tracks in random order.
- RANDOM OFF:** Cancels random playback mode.

MP3/WMA/AAC file:

- FOLDER RANDOM:** Plays all files in the selected folder in random order.
- ALL RANDOM:** Plays all files in random order.
- RANDOM OFF:** Cancels random playback mode.

### Set the disc type

While listening to a disc...

- 1 Touch **⊗** to enter [FUNCTION].
- 2 Touch **1▲ / 2▼** or **FOLDER ▲ / FOLDER ▼** to change to [SYSTEM SETTING], then touch **▶||** to select.
- 3 Touch **1▲ / 2▼** or **FOLDER ▲ / FOLDER ▼** to change to [CD READ SETTING], then touch **▶||** to select.
- 4 Touch **1▲ / 2▼** or **FOLDER ▲ / FOLDER ▼** to select an item below, then touch **▶||** to confirm.
  - MODE 1 (default):** Automatically distinguishes between audio file disc and music CD. ;
  - MODE 2:** Forces to play as a music CD. No sound can be heard if an audio file disc is played.
- 5 Touch **⊗** to exit.

To return to the previous setting item, touch **4↶**.

## 2Din CD Premium Audio (Models with Bluetooth features)

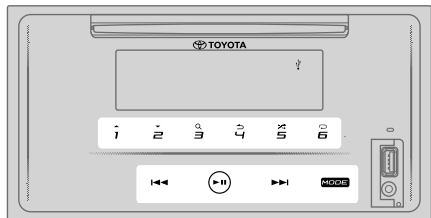

## 2Din CD Basic Audio (Models without Bluetooth features) Left-hand drive model:

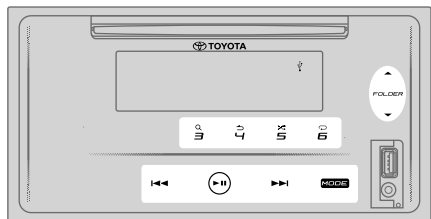

## Right-hand drive model:

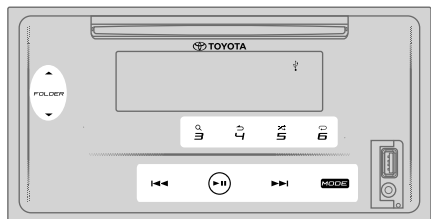

### CAUTION

- This product may not be compatible with all USB mass storage devices. We assume no responsibility for any loss of data on media players, smartphone, or other devices while using this product.
- Install the USB device in the place where it will not affect safe driving.
- Do not place the USB device and the connecting cables in the car to avoid damage by heat.

## Connecting a USB device

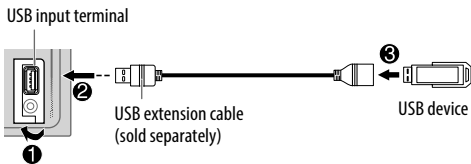

Connect a USB device to the USB input terminal using an USB extension cable.

- The source changes to “USB” and playback starts automatically.
- “USB” indicator lights up on the display window when USB device is connected.
- File number and play time appear on the display window for a few seconds when a USB device is connected. Then, other information appear. See [DISPLAY MODE] on page 18 for more information.
- If a USB device has already been connected, touch **MODE** repeatedly (or press **MODE** repeatedly on the remote control) to select “USB” as the playback source.

## Pause playback

Touch **II** (or press **ENT II** on the remote control) to pause the playback.

Play time will be displayed and blinking during pause.

## File up/down

Touch **II I** (or press **II I** on the remote control) to go to the next file.

Touch **I I I** (or press **I I I** on the remote control) to go to the previous file.

## Folder up/down

Touch **1 ▲** or **FOLDER ▲** to go to the next folder.

Touch **2 ▼** or **FOLDER ▼** to go to the previous folder.

### Note

- This function is available only when the USB device contains more than one folder.

## Selecting a file from the list

- 1 Touch **3Q** to display the list on the display window.
- 2 Touch **1▲ / 2▼** or **FOLDER ▲ / FOLDER ▼** to select your desired file.
- 3 Touch **▶||** to play the selected song.

To return to the previous setting item, touch **4↶**.

## Selecting a file from a folder

- 1 Touch **3Q** to display the list on the display window.
- 2 Touch **1▲ / 2▼** or **FOLDER ▲ / FOLDER ▼** to select your desired folder, then touch **▶||** to confirm.
- 3 Touch **1▲ / 2▼** or **FOLDER ▲ / FOLDER ▼** to select your desired file.
- 4 Touch **▶||** to play the selected song.

- To return to the top menu, touch **5**.
- To return to the previous setting item, touch **4↶**.
- To cancel, touch and hold **4↶**.

(or using the remote control)

- 1 Press **▲ / ▼** to display the list on the display window.
- 2 Press **▲ / ▼** to go to the next or previous folder.

### Note

- This function is available only when the USB device contains more than one folder.

## Direct Music Search (using the remote control)

- 1 Press **DIRECT**.
- 2 Press the number buttons to enter a file number.
- 3 Press **ENT ▶||** to search for music.

To cancel, press **↶** or **DIRECT**.

### Note

- Not available if Random Play is selected.

## Fast-forward/Fast-reverse

Touch and hold **▶▶|** (or press and hold **▶▶|** on the remote control) to fast-forward.

Touch and hold **|◀◀** (or press and hold **|◀◀** on the remote control) to fast-reverse.

## Repeat play

Touch **6↻** repeatedly to select the repeat playback mode.

MP3/WMA/AAC/WAV/FLAC file:

- SONG REPEAT:** Repeats the current file.
- FOLDER REPEAT:** Repeats all the files in the current folder.
- ALL REPEAT:** Repeats all the files in the current USB device.

## Random play

Touch **5↻** repeatedly to select the random playback mode.

MP3/WMA/AAC/WAV/FLAC file:

- FOLDER RANDOM:** Plays all files in the selected folder in random order.
- ALL RANDOM:** Plays all files in random order.
- RANDOM OFF:** Cancels random playback mode.

### NOTE

When connecting to some smartphone via USB, the display shows "NO DEVICE", which means the device is not compatible with this product. (➔ 33)

## 2Din CD Premium Audio (Models with Bluetooth features)

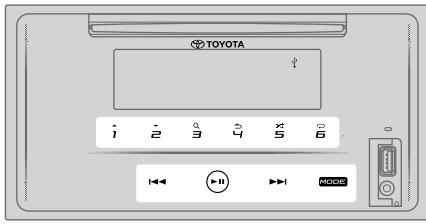

## 2Din CD Basic Audio (Models without Bluetooth features) Left-hand drive model:

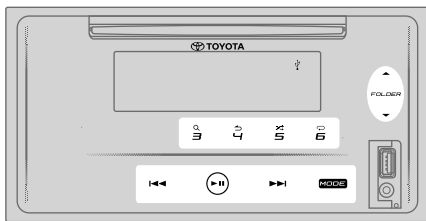

## Right-hand drive model:

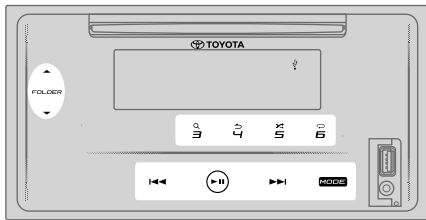

### CAUTION

- This product may not be compatible with all iPod/iPhone. We assume no responsibility for any loss of data on iPod/iPhone while using this product. Please back up your iPod/iPhone data regularly.
- Install the iPod/iPhone in the place where it will not affect safe driving.
- Do not leave the iPod/iPhone in direct sunlight for extended amounts of time. Extended exposure to direct sunlight can result in iPod/iPhone malfunction due to the resulting high temperature.
- Do not leave the iPod/iPhone in any location with high temperatures.
- Firmly secure the iPod/iPhone when driving. Do not let the iPod fall onto the floor, where it may become jammed under the brake or accelerator pedal.
- Do not place the iPod/iPhone and the connecting cables in the car to avoid damage by heat.

## Connecting an iPod/iPhone

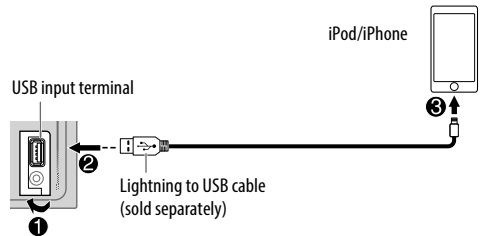

Connect an iPod/iPhone to the USB input terminal using a **Lightning to USB cable**.

- The source changes to "iPod USB" and playback starts automatically.
- "iPod" indicator lights up on the display window when iPod/iPhone is connected.
- File number and play time appear on the display window for a few seconds when an iPod/iPhone is connected. Then, other information appear. See [DISPLAY MODE] on page 18 for more information.
- If an iPod/iPhone has already been connected, touch **MODE** repeatedly (or press **MODE** repeatedly on the remote control) to select "iPod USB" as the playback source.

## Pause playback

Touch **II** (or press **ENT II** on the remote control) to pause the playback.  
Play time will be displayed and blinking during pause.

## Select control mode

Touch **4** repeatedly to select the control mode.

### MODE ON:

Control iPod/iPhone using the iPod/iPhone itself. However, you can still play/pause, file skip, fast-forward or reverse from this unit.

### MODE OFF:

Control iPod/iPhone from this unit.

## File up/down

Touch **II** (or press **II** on the remote control) to go to the next file.

Touch **I** (or press **I** on the remote control) to go to the previous file.



## Selecting a file from a list

- 1 Touch **3Q** to display the list on the display window.
- 2 Touch **1▲ / 2▼** or **FOLDER ▲ / FOLDER ▼** to select your desired list, then touch **▶||** to confirm.
- 3 Touch **1▲ / 2▼** or **FOLDER ▲ / FOLDER ▼** to select your desired file.
- 4 Touch **▶||** to play the selected song.

To return to the previous setting item, touch **4↵**.

## Selecting a file using alphabet search

If you have many files in the iPod/iPhone, you can search through them quickly according to the first character of the file name.

- 1 Touch **3Q** to display the list on the display window.
- 2 Touch **1▲ / 2▼** or **FOLDER ▲ / FOLDER ▼** to select your desired list.
- 3 Touch and hold **3Q** to display the menu for character search on the display window.
- 4 Touch **1▲ / 2▼** or **FOLDER ▲ / FOLDER ▼** to select your desired character.  
To search for a character other than A to Z and 0 to 9, enter only " \* ".
- 5 Touch **◀◀/▶▶** to move to the entry position.
  - You can enter up to 3 characters.
- 6 Touch **▶||** to start searching.
- 7 Touch **1▲ / 2▼** or **FOLDER ▲ / FOLDER ▼** to select your desired song.
- 8 Touch **▶||** to play the selected song.

- To return to the top menu, touch **5**.
- To return to the previous setting item, touch **4↵**.
- To cancel, touch and hold **4↵**.

### Note

- This function is applicable only when [MODE OFF] is selected.

## Fast-forward/Fast-reverse

Touch and hold **▶▶** (or press and hold **▶▶** on the remote control) to fast-forward.

Touch and hold **◀◀** (or press and hold **◀◀** on the remote control) to fast-reverse.

## Repeat play

Touch **6↻** repeatedly to select the repeat playback mode.

- SONG REPEAT: Repeats the current file.
- FOLDER REPEAT: Repeats all the files in the current list.
- REPEAT OFF: Cancels repeat playback mode.

## Random play

Touch **5↻** repeatedly to select the random playback mode.

- FOLDER RANDOM: Plays all files in the selected list in random order.
- ALL RANDOM: Plays all files in random order.
- RANDOM OFF: Cancels random playback mode.

## Listen to TuneIn Radio/TuneIn Radio Pro

While listening to TuneIn Radio or TuneIn Radio Pro, connect the iPod/iPhone to the USB input terminal of the unit.

- The unit will output the sound from these applications.

## Start listening

- 1 Connect a portable audio player (commercially available).

Auxiliary input jack

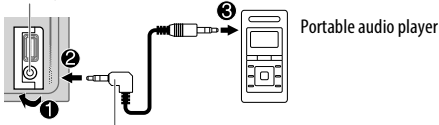

3.5 mm stereo mini plug with "L" shaped connector (sold separately)

- 2 Touch **MODE** repeatedly to select **AUX**.
- 3 Turn on the portable audio player and start playback.

### CAUTION

- Install the audio player in the place where it will not affect safe driving.
- Do not place the audio player and the connecting cable in the car to avoid damage by heat.

## Set the AUX name

While listening to a portable audio player connected to the unit...

- 1 Touch to enter [FUNCTION].
- 2 Touch 1 ▲ / 2 ▼ or FOLDER ▲ / FOLDER ▼ to select [SYSTEM SETTING], then touch ► II.
- 3 Touch 1 ▲ / 2 ▼ or FOLDER ▲ / FOLDER ▼ to select [AUX NAME SETTING], then touch ► II.
- 4 Touch 1 ▲ / 2 ▼ or FOLDER ▲ / FOLDER ▼ to select an item, then touch ► II.  
AUX (default) / DVD / PORTABLE / GAME / VIDEO / TV
- 5 Touch to exit.

To return to the previous setting item, touch 4 ➡.

(Only for models with Bluetooth features)

### WARNING

- Certain uses of an iPhone or a smartphone may not be legal while driving in your jurisdiction, so you must be aware of and obey any such restrictions.
- If in doubt as to a particular function, only perform it while the car is parked.
- No feature should be used unless it is safe to do so under the driving conditions you are experiencing.

Depending on the operating system and the firmware version of your mobile phone, some Bluetooth features may not work with this unit.

## BLUETOOTH — Connection

Bluetooth devices can be connected without cables and communicate with each other

### Supported Bluetooth profiles

- Hands-Free Profile (HFP)
- Advanced Audio Distribution Profile (A2DP)
- Audio/Video Remote Control Profile (AVRCP)
- Serial Port Profile (SPP)
- Phonebook Access Profile (PBAP)

### Supported Bluetooth codecs

- Sub Band Codec (SBC)
- Advanced Audio Coding (AAC)

## Pairing a Bluetooth device for the first time

- 1 Touch to turn on the unit.
- 2 Search and select "CAR MULTIMEDIA" on the Bluetooth device.  
"PAIRING (Device name)" ➡ "PASS XXXXXX" ➡ "PRESS PLAY/PAUSE" scrolls on the display.
  - For some Bluetooth devices, you may need to enter the Personal Identification Number (PIN) code immediately after searching.
- 3 Touch ► II to start pairing.  
"PAIRING OK" appears when pairing is completed.

indicator lights up on the display window when Bluetooth connection is established (see the illustration on page 27).

- This unit supports Secure Simple Pairing (SSP).
- Up to 5 devices can be registered (paired) in total.
- Once the pairing is completed, the Bluetooth device will remain registered in the unit even if you reset the unit. To delete the paired device, see [DEVICE DELETE] on page 29.
- A maximum of two Bluetooth phones and one Bluetooth audio device can be connected at any time. If you tried to connect the third phone, "MAXIMUM 2 PHONES CONNECTED" appears.
- Some Bluetooth devices may not automatically connect to the unit after pairing. Connect the device to the unit manually.
- Never turn this unit off while the paired Bluetooth device is being deleted.
- Refer to the instruction manual of the Bluetooth device for more information.

## BLUETOOTH — Hands-free

Left-hand drive model:

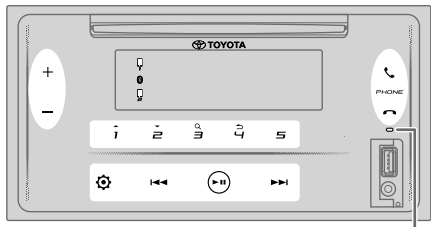

Built-in microphone

Right-hand drive model:

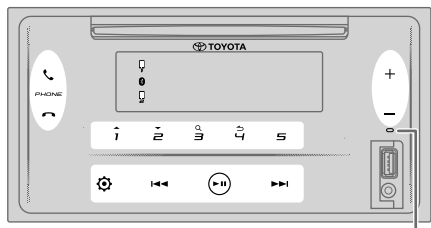

Built-in microphone

### Making a phone call

You can switch between two connected Bluetooth phones by pressing

#### Using the phonebook

- 1 Touch to enter Hands-free mode.
- 2 Touch 1▲ / 2▼ to change to [CONTACTS], then touch ►► to select.
- 3 Touch 1▲ / 2▼ to select a name, then touch ►► to confirm.
- 4 Touch 1▲ / 2▼ to select a phone number, then touch ►► to call.

If the phonebook contains many contacts, you can search for contacts using alphabet search mode.

- 1 Touch to enter Hands-free mode.
- 2 Touch 1▲ / 2▼ to change to [CONTACTS], then touch ►► to select.
- 3 Touch and hold 3Ⓚ to enter alphabet search mode. The first menu (ABCDEFGHIJKLMN) appears.
  - To go to the other menu (OPQRSTUVWXYZ1\*), touch 1▲ / 2▼.
- 4 Touch ◀◀ / ▶▶ to select the desired first letter, then touch ►► to confirm. Select "1" to search with numbers and select "\*" to search with symbols.
- 5 Touch 1▲ / 2▼ to select a name, then touch ►► to confirm.
- 6 Touch 1▲ / 2▼ to select a phone number, then touch ►► to call.

To return to the previous setting item, touch 4↶.

#### Note

- Applicable only if the phone supports PBAP.
- Depending on the setting of the phone, the phonebook of the connected phone is automatically transferred to the unit when pairing.
- Contacts are categorized as: HOME, OFFICE, MOBILE, OTHER, GENERAL.
- This unit can display only non-accent letters. (Accent letters such as "Ü" is shown as "U".)

#### Using the call history

- 1 Touch to enter Hands-free mode.
- 2 Touch 1▲ / 2▼ to change to [CALL HISTORY], then touch ►► to select.
- 3 Touch 1▲ / 2▼ to select a name or a phone number.
  - "INCOMING", "OUTGOING", OR "MISSED" is shown to indicate the previous call status.
  - "NO DATA" appears if there is no recorded call history.
- 4 Touch ►► to call.

#### Note

- Applicable only if the phone supports PBAP.



### Connecting a registered Bluetooth phone

- 1 Touch to enter "BT PHONE SELECT".
- 2 Touch one of the number button (1 to 5) to select a registered Bluetooth phone.
  - The name of the Bluetooth phone will be displayed. The following icons appear in front of the device name to indicate:
    - "\*": Device is connected.
    - "\_": Connecting the device.
    - (Blank): Device is disconnected or no operation. If there is no registered phone, "NO DEVICE" appears.
- 3 Touch ►► to connect a registered Bluetooth phone.
- 4 Touch to exit.

"" and/or "" indicator(s) light(s) up on the display window when the registered Bluetooth phone(s) is/are connected.

**To disconnect a registered Bluetooth phone:** Repeat steps 1 to 4. Select the desired Bluetooth phone to disconnect in step 2.

## Using the voice recognition

- 1 Touch  to enter Hands-free mode.
- 2 Touch 1▲ / 2▼ to change to [VOICE CONTROL], then touch ►|| to select.  
You can also activate the voice recognition of the connected phone by pressing and holding .
- 3 Speak the name of the contact you want to call or the voice command to control the phone functions.



### Note



- Supported Voice Recognition features vary for each phone. Refer to the instruction manual of the connected phone for details.
- This unit also supports the intelligent personal assistant function of iPhone.

## Answering a phone call

When there is an incoming call, the unit will ring.

## Receiving a call

Touch  (or press  on the remote control) to answer the first incoming call.

While talking on the first incoming call, you can answer another incoming call by touching  (or pressing  on the remote control).

- The first incoming call will be put on-hold.



## Operation during phone call





### Adjusting the phone volume

Touch + / - (or press **VOL ▲** / **VOL ▼** on the remote control) during a call to adjust the phone volume ([00] to [35]).

- Touching and holding + (or pressing and holding **VOL ▲** on the remote control) continuously increase the volume to [25].
- This adjustment will not affect the volume of the other sources.
- By default, volume [15] is selected.

### Ending or rejecting a call

Touch  (or press  on the remote control) to end the current call or reject an incoming call.

- While talking on the first incoming call, you can reject another incoming call by touching  (or pressing  on the remote control).
- Touching  (or pressing  on the remote control) while having two active calls will end the current call and activate the held call.



### Switching between hands-free mode and private talk mode

Touch **6** during a call to switch between hands-free mode and private talk mode.



### Note

- Operations may vary according to the connected Bluetooth device.

## Switching between active calls



Touch  (or press  on the remote control) to swap between current call and held call.

## Adjusting the sensitivity of the microphone

- 1 Touch  to enter [FUNCTION].
- 2 Touch 1▲ / 2▼ to change to [MIC GAIN], then touch ►|| to select.
- 3 Touch 1▲ / 2▼ to adjust the sensitivity level of the microphone ([LEVEL -10] to [LEVEL +10]).  
The sensitivity of the microphone increases as the number increased.
- 4 Touch ►|| to select the level.
- 5 Touch  to exit.



To return to the previous setting item, touch **4** ↩.

## Adjusting the noise reduction level

- 1 Touch  to enter [FUNCTION].
- 2 Touch 1▲ / 2▼ to change to [NR LEVEL], then touch ►|| to select.
- 3 Touch 1▲ / 2▼ to adjust the noise reduction level ([LEVEL -5] to [LEVEL +5]).  
Adjust the noise reduction level until the least noise is being heard during a phone conversation.
- 4 Touch ►|| to select the level.
- 5 Touch  to exit.

To return to the previous setting item, touch **4** ↩.





## Adjusting the echo level

- 1 Touch  to enter [FUNCTION].
- 2 Touch 1▲ / 2▼ to change to [ECHO CANCEL], then touch ►|| to select.
- 3 Touch 1▲ / 2▼ to adjust the echo cancellation delay time ([LEVEL -5] to [LEVEL +5]).  
Adjust the echo cancellation delay time until the least echo is being heard during a phone conversation.
- 4 Touch ►|| to select the level.
- 5 Touch  to exit.

To return to the previous setting item, touch **4** ↩.

## Other settings

### Selecting the Bluetooth phone to connect or disconnect





- 1 Touch  to enter [FUNCTION].
- 2 Touch 1▲ / 2▼ to change to [BT MODE SETTING], then touch  to select.
- 3 Touch 1▲ / 2▼ to change to [PHONE SELECT], then touch  to select.
- 4 Touch 1▲ / 2▼ to select a Bluetooth phone to connect or disconnect, then touch  to confirm. "\*" appears in front of the device name when connected.
- 5 Touch  to exit.

To return to the previous setting item, touch .

#### Note

- You can only connect a maximum of two Bluetooth phones at any time.

### Selecting a Bluetooth audio device to connect or disconnect







- 1 Touch  to enter [FUNCTION].
- 2 Touch 1▲ / 2▼ to change to [BT MODE SETTING], then touch  to select.
- 3 Touch 1▲ / 2▼ to change to [AUDIO SELECT], then touch  to select.
- 4 Touch 1▲ / 2▼ to select a Bluetooth audio device to connect or disconnect, then touch  to confirm. "\*" appears in front of the device name when connected. "▷" appears when the device is connected and playing.
- 5 Touch  to exit.

To return to the previous setting item, touch .

#### Note







- You can only connect a maximum of one Bluetooth audio device at any time.

### Deleting a Bluetooth device

- 1 Touch  to enter [FUNCTION].
- 2 Touch 1▲ / 2▼ to change to [BT MODE SETTING], then touch  to select.
- 3 Touch 1▲ / 2▼ to change to [DEVICE DELETE], then touch  to select.
- 4 Touch 1▲ / 2▼ to select a device to delete, then touch  to confirm.
- 5 Touch 1▲ / 2▼ to select [YES], then touch  to confirm. Selecting [NO] will cancel the deleting device feature.
- 6 Touch  to exit.

To return to the previous setting item, touch .

### Changing the PIN code





- 1 Touch  to enter [FUNCTION].
- 2 Touch 1▲ / 2▼ to change to [BT MODE SETTING], then touch  to select.
- 3 Touch 1▲ / 2▼ to change to [CHANGE PIN CODE], then touch  to select.
- 4 Touch 1▲ / 2▼ to select a number.
- 5 Touch  /  to move the entry position. Repeat steps 4 and 5 until you finish entering the PIN code.
- 6 Touch  to confirm.
- 7 Touch  to exit.

To return to the previous setting item, touch .

#### Note





- You can change the PIN code up to 6 digits.
- By default, [0000] is selected.

### Setting the auto reconnect feature

- 1 Touch  to enter [FUNCTION].
- 2 Touch 1▲ / 2▼ to change to [BT MODE SETTING], then touch  to select.
- 3 Touch 1▲ / 2▼ to change to [RECONNECT SETTING], then touch  to select.
- 4 Touch 1▲ / 2▼ to select [ON] to allow the unit to automatically reconnect when the last connected Bluetooth device is within range. Selecting [OFF] will cancel the auto reconnect feature.
- 5 Touch  to confirm.
- 6 Touch  to exit.

To return to the previous setting item, touch .

### Setting the initialize feature

- 1 Touch  to enter [FUNCTION].
- 2 Touch 1▲ / 2▼ to change to [BT MODE SETTING], then touch  to select.
- 3 Touch 1▲ / 2▼ to change to [INITIALIZE SETTING], then touch  to select.
- 4 Touch 1▲ / 2▼ to select [YES] to initialize all the Bluetooth settings (including stored pairing, phonebook, and etc.). Selecting [NO] will cancel the initialize setting feature.
- 5 Touch  to confirm.
- 6 Touch  to exit.

To return to the previous setting item, touch .

## BLUETOOTH — Audio

- While in BT AUDIO source, you can connect up to five Bluetooth audio devices and switch between these five devices. See “Switch between Bluetooth audio devices” on page 31.
- Depending on the selected phone or Bluetooth audio device, playback may not start automatically.

Operations and display indications may differ according to their availability on the connected device.

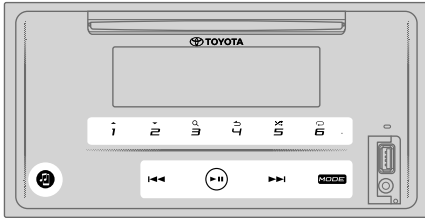

### Audio player via Bluetooth

- 1 Touch **MODE** repeatedly to select BT AUDIO (or press **MODE** repeatedly on the remote control). Touching enters BT AUDIO directly.
- 2 Operate the audio player via Bluetooth to start playback.

### File up/down

Touch (or press on the remote control) to go to the next file.

Touch (or press on the remote control) to go to the previous file.

### Group or folder up/down

Touch to go to the next group or folder.

Touch to go to the previous group or folder.

### Note

- This function is available depends on your connected Bluetooth audio player and only when the Bluetooth audio player contains more than one group or one folder.

### Selecting a file from the list

- 1 Touch to display the list on the display window.
- 2 Touch / to select your desired file.
- 3 Touch to play the selected song.

To return to the previous setting item, touch .

### Selecting a file from a group or folder

- 1 Touch to display the list on the display window.
- 2 Touch / to select your desired group or folder, then touch to confirm.
- 3 Touch / to select your desired file.
- 4 Touch to play the selected song.

- To return to the previous setting item, touch .
- To cancel, touch and hold .

(or using the remote control)

- 1 Press / to display the list on the display window.
- 2 Press / to go to the next or previous folder.

### Note

- This function is available depends on your connected Bluetooth audio player and only when the Bluetooth audio player contains more than one group or one folder.

### Pause playback

Touch (or press **ENT** on the remote control) to pause the playback.

Play time will be displayed and blinking during pause.

### Fast-forward/Fast-reverse

Touch and hold (or press and hold on the remote control) to fast-forward.

Touch and hold (or press and hold on the remote control) to fast-reverse.

### Repeat play

Touch repeatedly to select the repeat playback mode.

**SONG REPEAT:** Repeats the current file.

**ALL REPEAT:** Repeats all the files in the current drive.

**REPEAT OFF:** Cancels repeat playback mode.

### Random play

Touch repeatedly to select the random playback mode.

**FOLDER RANDOM:** Plays all files in the selected folder in random order.

**GROUP RANDOM:** Plays all files in the selected group in random order.



**ALL RANDOM:** Plays all files in random order.

**RANDOM OFF:** Cancels random playback mode.

# BLUETOOTH®

## Switch between Bluetooth audio devices

While in BT AUDIO source...

- 1 Touch  to enter "AUDIO SELECT".
- 2 Touch one of the number button (1 to 5) to select a Bluetooth audio device.  
The name of the Bluetooth audio device will be displayed.
- 3 Touch  to connect and play the selected device.

- 4 Repeat step 2 and 3 to change the Bluetooth audio device.

- The following icons appear in front of the device name to indicate:  
"∗": Device is connected and playing (active).  
(Blank): Device is not connected or device is connected but no operation.

If there is no registered device, "NO DEVICE" appears.

- 5 Touch  to exit.

## REFERENCES

### Playable media and files

You can play various kinds of media and files on this unit.

Media type / standard	Support	Remark	
CD	Music CD*	○	
	CD-ROM	○	• MP3 (.mp3), WMA (.wma), AAC (.aac) • Multisession is supported • Packet write is not supported
	CD-R	○	
	CD-RW	○	
	DTS CD	×	
	Video CD (VCD)	×	
	Super video CD	×	
	Photo CD	×	
	CD-EXTRA	△	Only music CD session can be played.
	HDCD	△	Normal music CD sound quality.
CCCD	×		
Others disc	DualDisc	×	
	Super audio CD	△	Only CD layer can be played.
USB mass storage class device	○	MP3 (.mp3), WMA (.wma), AAC (.aac), AAC (.m4a), WAV (.wav), FLAC (.flac)	

\* Incompatible with 8 cm (3 inch) discs.

- Playable disc file format: ISO 9660 Level 1/2, Joliet, Long file name
- Playable USB device file system: FAT12, FAT16, FAT32

Even when audio files comply with the standards listed above, playback may be impossible depending on the types or conditions of media or device.

The AAC (.m4a) file in a CD encoded by iTunes cannot be played on this unit.

# TROUBLESHOOTING

If you have problems operating this product, refer to this section. The most common problems are listed below, along with likely causes and solutions. If a solution to your problem cannot be found here, contact your dealer or your nearest Toyota Service Centre.

When problems occur with this product, an error message appears on the display. Refer to the table below to identify the problem, then take the suggested corrective action. There are occasions when you may see error messages other than those shown here. In such a case, follow the instructions given on the display. If the error persists, record the error message and contact your dealer or your nearest Toyota Service Centre.

## In case of trouble

Should this product fail to operate properly, contact your dealer or nearest authorised Toyota Service Station.

	Symptom	Remedy
General	Sound cannot be heard.	<ul style="list-style-type: none"> <li>Adjust the volume to the optimum level.</li> <li>Check the cords and connections.</li> </ul>
	"MISWIRING CHECK WIRING THEN PWR ON" appears.	Turn the power off, then check to be sure the terminals of the speaker wires are insulated properly. Turn the power on again.
	"PROTECT" appears.	Go to the nearest Toyota service center.
	The unit does not work at all.	Reset the unit. (➔ 6, 8)
	Correct characters are not displayed.	<ul style="list-style-type: none"> <li>This unit can only display uppercase letters, numbers, and a limited number of symbols.</li> <li>Depending on the display language you have selected (➔ 15), some characters may not be displayed correctly.</li> </ul>
Radio	<ul style="list-style-type: none"> <li>Radio reception is poor.</li> <li>Static noise while listening to the radio.</li> </ul>	Connect the antenna firmly.
	Disc cannot be ejected.	Touch and hold ▲ to forcibly eject the disc. Be careful not to drop the disc when it is ejected. If this does not solve the problem, reset the unit. (➔ 6, 8)
CD/USB/iPod	Noise is generated.	Skip to another track or change the disc.
	"PLEASE EJECT" appears.	Reset the unit (➔ 6, 8). If this does not solve the problem, consult your nearest Toyota service center.
	Playback order is not as intended.	The playback order is determined by the order in which files were recorded (disc) or the file name (USB).
	"READING" keeps flashing.	<ul style="list-style-type: none"> <li>Do not use too many hierarchical levels or folders.</li> <li>Reload the disc or reattach the device (USB/iPod/iPhone).</li> </ul>
	Elapsed playing time is not correct.	This depends on the recording process earlier (disc/USB).
	"UNRESPONSIVE DEVICE" appears.	Make sure the USB device is not malfunction and reattach the USB device.
	"USB HUB IS NOT SUPPORTED" appears.	This unit cannot support a USB device connected via a USB hub.
	<ul style="list-style-type: none"> <li>The source does not change to "USB" when you connect a USB device while listening to another source.</li> <li>"USB ERROR" appears.</li> </ul>	The USB port is drawing more power than the design limit. Turn the power off and unplug the USB device. Then, turn on the power and reattach the USB device. If this does not solve the problem, turn the power off and on (or reset the unit) before replacing with another USB device.
	The iPod/iPhone does not turn on or does not work.	<ul style="list-style-type: none"> <li>Check the connection between this unit and iPod/iPhone.</li> <li>Disconnect and reset the iPod/iPhone using hard reset.</li> </ul>



## TROUBLESHOOTING

	Symptom	Remedy
CD/USB/iPod	"LOADING" appears when you enter search mode by touching <b>3Q</b> .	This unit is still preparing the iPod/iPhone music list. It may take some time to load, try again later.
	"NO DISC"	Insert a playable disc into the loading slot.
	"TOC ERROR"	Make sure the disc is clean and inserted properly.
	"NA FILE"	Make sure the media (disc/USB) contains supported audio files. (➔ 4, 31)
	"COPY PRO"	A copy-protected file is played (disc/USB).
	"NO DEVICE"	<ul style="list-style-type: none"> <li>• Connect a device (USB), and change the source to USB again.</li> <li>• The connected USB device is not compatible with this unit. (➔ 4)</li> </ul>
	"NO MUSIC"	<ul style="list-style-type: none"> <li>• Connect a device (USB) that contains playable audio files.</li> <li>• Make sure the file systems are in supported formats (➔ 31) and reattach the USB device.</li> </ul>
	"iPod ERROR"	<ul style="list-style-type: none"> <li>• Reconnect the iPod.</li> <li>• Reset the iPod.</li> </ul>
	"NO SUPPORT"	<ul style="list-style-type: none"> <li>• The connected USB device is not compatible with this unit.</li> </ul>
Bluetooth®	No Bluetooth device is detected.	<ul style="list-style-type: none"> <li>• Search from the Bluetooth device again.</li> <li>• Reset the unit. (➔ 6, 8)</li> </ul>
	Pairing cannot be made.	<ul style="list-style-type: none"> <li>• Make sure you have entered the same PIN code to both the unit and Bluetooth device.</li> <li>• Delete pairing information from both the unit and the Bluetooth device, then perform pairing again. (➔ 26)</li> </ul>
	Echo or noise is heard during a phone conversation.	Check the [ECHO CANCEL] setting. (➔ 28)
	Phone sound quality is poor.	<ul style="list-style-type: none"> <li>• Reduce the distance between the unit and the Bluetooth device.</li> <li>• Move the car to a place where you can get a better signal reception.</li> </ul>
	Voice calling method is not successful.	<ul style="list-style-type: none"> <li>• Use voice calling method in a more quiet environment.</li> <li>• Reduce the distance from the microphone when you speak the name.</li> <li>• Make sure the same voice as the registered voice tag is used.</li> </ul>
	Sound is being interrupted or skipped during playback of a Bluetooth audio player.	<ul style="list-style-type: none"> <li>• Reduce the distance between the unit and the Bluetooth audio player.</li> <li>• Turn off, then turn on the unit and try to connect again.</li> <li>• Other Bluetooth devices might be trying to connect to the unit.</li> </ul>
	The connected Bluetooth audio player cannot be controlled.	<ul style="list-style-type: none"> <li>• Check whether the connected Bluetooth audio player supports Audio/Video Remote Control Profile (AVRCP). (Refer to the instructions of your audio player.)</li> <li>• Disconnect and connect the Bluetooth player again.</li> </ul>
	"NOT SUPPORT"	The connected phone does not support Voice Recognition feature or phonebook transfer.
	"NO ENTRY"/"NO PAIR"/"NO DEVICE"	There is no registered device connected/found via Bluetooth.
	"ERROR"	Try the operation again. If "ERROR" appears again, check if the device supports the function you have tried.
	"NO INFO"/"NO DATA"	Bluetooth device cannot get the contact information.
	"HF ERROR XX"/"BT ERROR"	Reset the unit (➔ 6, 8) and try the operation again. If this does not solve the problem, consult your nearest service center.
	The Bluetooth connection between the Bluetooth device and the unit is unstable.	Delete the unused registered Bluetooth device from the unit. (➔ 29)

# SPECIFICATIONS

Radio	FM	Frequency Range	For Asia Pacific: 87.5 MHz — 108.0 MHz (50 kHz space) For Oceanic / GCC: 87.5 MHz — 108.0 MHz (Manual: 50 kHz space; Auto: 100 kHz space) For Central South America: 87.4 MHz — 108.0 MHz (100 kHz space)
		Usable Sensitivity (S/N = 30 dB)	-2.0 dBμ
		Frequency Response (±3 dB)	100 Hz — 10 kHz
		Signal-to-Noise Ratio (MONO)	58 dB
		Stereo Separation (1 kHz)	40 dB
AM	Frequency Range	For Asia Pacific / GCC / Oceanic: 531 kHz — 1 602 kHz (9 kHz space) For Central South America: 530 kHz — 1 620 kHz (Manual: 5 kHz space; Auto: 10 kHz space)	
		Channel Space Selection	For Asia Pacific / GCC / Oceanic: Band 1 / 9 kHz For Central South America: Band 1 (Manual: 5 kHz space; Auto: 10 kHz space)
		Usable Sensitivity (S/N = 20 dB)	30 dBμ

CD player	Laser Diode	GaAlAs
	Digital Filter (D/A)	8 times over sampling
	Spindle Speed	500 rpm — 200 rpm (CLV)
	Wow & Flutter	Below measurable limit
	Frequency Response (±1 dB)	31 Hz — 20 kHz
	Total Harmonic Distortion (1 kHz)	0.02 %
	Signal-to-Noise Ratio (1 kHz)	85 dB
	Dynamic Range	80 dB
	Channel Separation	70 dB
	MP3 Decode	Compliant with MPEG-1/2 Audio Layer-3
WMA Decode	Compliant with Windows Media Audio	
AAC Decode	AAC-LC “.aac” files	

USB	USB Standard	USB 1.1, USB 2.0 (Full speed)
	File System	FAT12/16/32
	Maximum Supply Current	DC 5 V ≐ 1.0 A

USB	MP3 Decode	Compliant with MPEG-1/2 Audio Layer-3
	WMA Decode	Compliant with Windows Media Audio
	AAC Decode	AAC-LC “.aac”, “.m4a” files
	WAV Decode	Linear-PCM
FLAC Decode	FLAC file (Up to 48 kHz/16 bit)	

Only for 2Din CD Premium Audio (models with Bluetooth features)

Bluetooth	Version	Bluetooth 3.0
	Frequency Range	2.402 GHz — 2.480 GHz
	Output Power	+4 dBm (MAX), 0 dBm (AVE) Power Class 2
	Maximum Communication Range	Line of sight approx. 10 m (32.8 ft)
	Profile	HFP (Hands-Free Profile) SPP (Serial Port Profile) PBAP (Phonebook Access Profile) A2DP (Advanced Audio Distribution Profile) AVRCP (Audio/Video Remote Control Profile)

Audio	Maximum Power Output	50 W × 4	
	Full Bandwidth Power	20 W × 4 (at less than 10 % THD)	
	Speaker Impedance	4 Ω — 8 Ω	
	Tone Action	Band1	62.5 Hz ±9 dB
		Band2	100 Hz ±9 dB
		Band3	160 Hz ±9 dB
		Band4	250 Hz ±9 dB
		Band5	400 Hz ±9 dB
		Band6	630 Hz ±9 dB
		Band7	1 kHz ±9 dB
		Band8	1.6 kHz ±9 dB
		Band9	2.5 kHz ±9 dB
		Band10	4 kHz ±9 dB
Band11		6.3 kHz ±9 dB	
Band12		10 kHz ±9 dB	
Band13		16 kHz ±9 dB	

Auxiliary	Frequency Response (±3 dB)	20 Hz — 20 kHz
	Input Maximum Voltage	1 000 mV
	Input Impedance	30 kΩ

General	Operating Voltage	14.4 V (10.5 V — 16 V allowable)
	Maximum Current Consumption	10 A
	Dimensions (W × H × D)	205.5 mm × 104 mm × 168.5 mm
	Weight	1.38 kg

Subject to change without notice.

# SOFTWARE LICENSE AGREEMENT

The software embedded in the Product (hereinafter the "Licensed Software") provided by Licensor is copyrighted to or sublicensable by the Licensor, and this Agreement provides for the terms and conditions which Users shall follow in order to use the Licensed Software.

The User shall use the Licensed Software by agreeing with the terms of this Software License Agreement. This Agreement shall be deemed completed at the time the User (hereinafter the "User") initially used the Product in which the "Licensed Software" is embedded.

The Licensed Software may include the software which has been licensed to the Licensor directly or indirectly from any third party. In such case, some third parties require the Users to follow their conditions for use separately from this Software License Agreement. Such software shall not be subject to this Agreement, and the Users are urged to read the "Important Notice concerning the Software" to be provided separately below.

## Article 1 General Provision

The Licensor shall grant to the User a non-exclusive and non-transferable (other than the exceptional case referred to in Article 3, Paragraph 1) licensed to use the Licensed Software within the country of the User. (the country where the User bought the Product (hereinafter the "Country"))

## Article 2 License

1. The license granted under this Agreement shall be the right to use the Licensed Software in the Product.
2. The User shall not duplicate, copy, modify, add, translate or otherwise alter, or lease the Licensed Software and any related documents, whether in whole or in part.
3. The use of the Licensed Software shall be limited to personal purpose, and the Licensed Software shall not be distributed, licensed or sub-licensed whether it is for commercial purpose or not.
4. The User shall use the Licensed Software according to the directions described in the operation manual or help file, and is prohibited to use or duplicate any data in a manner violating the Copyright Law or any other laws and regulations by applying whole or a part of the Licensed Software.

## Article 3 Conditions for Grant of License

1. When the User transfers the Product, it may also transfer the license to use the Licensed Software embedded in the Product (including any related materials, updates and upgrades) on condition that no original, copies or related materials continue in the possession of the User, and that the User shall cause the transferee to comply with this Software License Agreement.
2. The User shall not carry out reverse engineering, disassembling, decompiling or any other code analysis works in connection with the Licensed Software.

## Article 4 Right pertaining to the Licensed Software

Any and all copyrights and other rights pertaining to the Licensed Software and related documents shall belong to the Licensor or the original holder of the right who granted to the Licensor the license or sublicense for the Licensed Software (hereinafter the "Original Rightholder"), and the User shall not be entitled to any right other than the license granted hereunder, in respect of the Licensed Software and any related documents.

## Article 5 Indemnification of Licensor

1. Neither the Licensor nor the Original Rightholder shall be liable for any damage incurred by the User or any third party due to the exercise of the license granted to the User under this Agreement, unless otherwise restricted by law.
2. The Licensor will offer no guarantee for the merchantability, convertibility and consistency with certain objective of the Licensed Software.

## Article 6 Liability to Third Party

If any dispute has arisen with any third party due to an infringement upon a copyright, patent or any other intellectual property right that was caused by the User's use of the Licensed Software, the User shall settle such dispute at its own cost and hold the Licensor and the Original Rightholder harmless from any inconvenience it may cause.

## Article 7 Confidentiality

The User shall keep the confidentiality of such portion of the Licensed Software, related documents thereof or any other information to be granted under this Agreement, as well as the conditions of this Agreement as has not yet entered the public domain, and shall not disclose or divulge the same to any third party without approval of the Licensor.

## Article 8 Termination

In case the User falls under any of the events described in the following items, the Licensor may immediately terminate this Agreement or claim that the User compensates for the damage incurred by the Licensor due to such event:

- (1) when the User violated any provision of this Agreement; or
- (2) when a petition has been filed against the User for an attachment, provisional attachment, provisional disposition or any other compulsory execution.

## Article 9 Destruction of the Licensed Software

If this Agreement is terminated pursuant to the provision of Article 8, the User shall destroy the Licensed Software, any related documents and copies thereof within two (2) weeks from such date of termination.

## Article 10 Protection of Copyright

1. The copyright and all the other intellectual property rights relating to the Licensed Software shall belong to the Licensor and the Original Rightholder, and in no event shall they be under the ownership of the User.
2. The User shall, whenever it uses the Licensed Software, comply with any laws relating to the copyright and other intellectual property rights.

## Article 11 Export Restriction

1. It is prohibited to export the Licensed Software and any related documents outside the country of the User (including transmission thereof outside the country of the User via Internet of other communication tools).
2. The User shall understand that the Licensed Software shall be subject to the export restrictions adopted by the country of User and any other countries.
3. The User shall agree that the software will be subject to any and all applicable international and domestic laws (including the export control regulation of the country of User and any other countries, and any restrictions concerning the end-users, the use by end-users and importing countries to be provided by the country of User and any other countries, and any other governmental authorities).

## Article 12 Miscellaneous

1. In the event any part of this Agreement is invalidated by operation of law, the residual provisions shall continue in force.
2. Matters not stipulated in this Agreement or any ambiguity or question raised in the construction of this Agreement shall be provided or settled upon good-faith consultation between the Licensor and the User.
3. The Licensor and the User hereby agree that this Agreement is governed by the laws of Japan, and any dispute arising from, and relating to the rights and obligations under, this Agreement shall be submitted to the exclusive jurisdiction of the Tokyo District Court for its first instance.

## Important Notice concerning the Software

-jansson

Copyright (c) 2009-2012 Petri Lehtinen <petri@digip.org>

Permission is hereby granted, free of charge, to any person obtaining a copy of this software and associated documentation files (the "Software"), to deal in the Software without restriction, including without limitation the rights to use, copy, modify, merge, publish, distribute, sublicense, and/or sell copies of the Software, and to permit persons to whom the Software is furnished to do so, subject to the following conditions:

The above copyright notice and this permission notice shall be included in all copies or substantial portions of the Software.

THE SOFTWARE IS PROVIDED "AS IS", WITHOUT WARRANTY OF ANY KIND, EXPRESS OR IMPLIED, INCLUDING BUT NOT LIMITED TO THE WARRANTIES OF MERCHANTABILITY, FITNESS FOR A PARTICULAR PURPOSE AND NONINFRINGEMENT. IN NO EVENT SHALL THE AUTHORS OR COPYRIGHT HOLDERS BE LIABLE FOR ANY CLAIM, DAMAGES OR OTHER LIABILITY, WHETHER IN AN ACTION OF CONTRACT, TORT OR OTHERWISE, ARISING FROM, OUT OF OR IN CONNECTION WITH THE SOFTWARE OR THE USE OR OTHER DEALINGS IN THE SOFTWARE.

-cJSON

Copyright (c) 2009 Dave Gamble

Permission is hereby granted, free of charge, to any person obtaining a copy of this software and associated documentation files (the "Software"), to deal in the Software without restriction, including without limitation the rights to use, copy, modify, merge, publish, distribute, sublicense, and/or sell copies of the Software, and to permit persons to whom the Software is furnished to do so, subject to the following conditions:

The above copyright notice and this permission notice shall be included in all copies or substantial portions of the Software.

THE SOFTWARE IS PROVIDED "AS IS", WITHOUT WARRANTY OF ANY KIND, EXPRESS OR IMPLIED, INCLUDING BUT NOT LIMITED TO THE WARRANTIES OF MERCHANTABILITY, FITNESS FOR A PARTICULAR PURPOSE AND NONINFRINGEMENT. IN NO EVENT SHALL THE AUTHORS OR COPYRIGHT HOLDERS BE LIABLE FOR ANY CLAIM, DAMAGES OR OTHER LIABILITY, WHETHER IN AN ACTION OF CONTRACT, TORT OR OTHERWISE, ARISING FROM, OUT OF OR IN CONNECTION WITH THE SOFTWARE OR THE USE OR OTHER DEALINGS IN THE SOFTWARE.

-CMP

The MIT License (MIT)

Copyright (c) 2014 Charles Gunyon

Permission is hereby granted, free of charge, to any person obtaining a copy of this software and associated documentation files (the "Software"), to deal in the Software without restriction, including without limitation the rights to use, copy, modify, merge, publish, distribute, sublicense, and/or sell copies of the Software, and to permit persons to whom the Software is furnished to do so, subject to the following conditions:

The above copyright notice and this permission notice shall be included in all copies or substantial portions of the Software.

THE SOFTWARE IS PROVIDED "AS IS", WITHOUT WARRANTY OF ANY KIND, EXPRESS OR IMPLIED, INCLUDING BUT NOT LIMITED TO THE WARRANTIES OF MERCHANTABILITY, FITNESS FOR A PARTICULAR PURPOSE AND NONINFRINGEMENT. IN NO EVENT SHALL THE AUTHORS OR COPYRIGHT HOLDERS BE LIABLE FOR ANY CLAIM, DAMAGES OR OTHER LIABILITY, WHETHER IN AN ACTION OF CONTRACT, TORT OR OTHERWISE, ARISING FROM, OUT OF OR IN CONNECTION WITH THE SOFTWARE OR THE USE OR OTHER DEALINGS IN THE SOFTWARE.

# IMPORTANT NOTICE

## FCC WARNING

This equipment may generate or use radio frequency energy. Changes or modifications to this equipment may cause harmful interference unless the modifications are expressly approved in the instruction manual. The user could lose the authority to operate this equipment if an unauthorized change or modification is made.

## FCC NOTE

This equipment has been tested and found to comply with the limits for a Class B digital device, pursuant to Part 15 of the FCC Rules. These limits are designed to provide reasonable protection against harmful interference in a residential installation. This equipment may cause harmful interference to radio communications, if it is not installed and used in accordance with the instructions. However, there is no guarantee that interference will not occur in a particular installation. If this equipment does cause harmful interference to radio or television reception, which can be determined by turning the equipment off and on, the user is encouraged to try to correct the interference by one or more of the

following measures:

- Reorient or relocate the receiving antenna.
- Increase the separation between the equipment and receiver.
- Connect the equipment into an outlet on a circuit different from that to which the receiver is connected.
- Consult the dealer or an experienced radio/TV technician for help.



**Declaration of Conformity with regard to the RE Directive 2014/53/EU**  
**Declaration of Conformity with regard to the RoHS Directive 2011/65/EU**

## Manufacturer:

JVC KENWOOD Corporation  
3-12, Moriya-cho, Kanagawa-ku, Yokohama-shi, Kanagawa, 221-0022, JAPAN

## EU Representative:

JVCKENWOOD Europe B.V.  
Amsterdamseweg 37, 1422 AC UITHOORN, THE NETHERLANDS

## English

Hereby, JVCKENWOOD declares that the radio equipment "DPXGT702L/ DPXGT701R/ DPXGT700R/ DPXGT502L/ DPXGT500R" is in compliance with Directive 2014/53/EU.

The full text of the EU declaration of conformity is available at the following internet address:  
<http://www.kenwood.com/cs/ce/eudoc/>

## Français

Par la présente, JVCKENWOOD déclare que l'équipement radio « DPXGT702L/ DPXGT701R/ DPXGT700R/ DPXGT502L/ DPXGT500R » est conforme à la directive 2014/53/UE.

L'intégralité de la déclaration de conformité UE est disponible à l'adresse Internet suivante :  
<http://www.kenwood.com/cs/ce/eudoc/>

## Español

Por la presente, JVCKENWOOD declara que el equipo de radio "DPXGT702L/ DPXGT701R/ DPXGT700R/ DPXGT502L/ DPXGT500R" cumple la Directiva 2014/53/UE.

El texto completo de la declaración de conformidad con la UE está disponible en la siguiente dirección de internet:  
<http://www.kenwood.com/cs/ce/eudoc/>

## Português

Deste modo, a JVCKENWOOD declara que o equipamento de rádio "DPXGT702L/ DPXGT701R/ DPXGT700R/ DPXGT502L/ DPXGT500R" está em conformidade com a Diretiva 2014/53/UE.

O texto integral da declaração de conformidade da UE está disponível no seguinte endereço de internet:  
<http://www.kenwood.com/cs/ce/eudoc/>

## IMPORTANT NOTICE



### The marking of products using lasers

The label is attached to the chassis/case and says that the component uses laser beams that have been classified as Class 1. It means that the unit is utilizing laser beams that are of a weaker class. There is no danger of hazardous radiation outside the unit.

- Microsoft and Windows Media are either registered trademarks or trademarks of Microsoft Corporation in the United States and/or other countries.
- Use of the Made for Apple badge means that an accessory has been designed to connect specifically to the Apple product(s) identified in the badge, and has been certified by the developer to meet Apple performance standards. Apple is not responsible for the operation of this device or its compliance with safety and regulatory standards. Please note that the use of this accessory with an Apple product may affect wireless performance.
- Apple, iPhone, iPod, iPod classic, iPod nano, iPod touch, and Lightning are trademarks of Apple Inc., registered in the U.S. and other countries.
- The "AAC" logo is a trademark of Dolby Laboratories.
- The Bluetooth® word mark and logos are registered trademarks owned by the Bluetooth SIG, Inc. and any use of such marks by JVC KENWOOD Corporation is under license. Other trademarks and trade names are those of their respective owners.
- The names of private corporations, products and other entities described in this product are the registered trademarks or trademarks of their respective firms.

### libFLAC

Copyright (C) 2000-2009 Josh Coalson

Copyright (C) 2011-2013 Xiph.Org Foundation

Redistribution and use in source and binary forms, with or without modification, are permitted provided that the following conditions are met:

- Redistributions of source code must retain the above copyright notice, this list of conditions and the following disclaimer.
- Redistributions in binary form must reproduce the above copyright notice, this list of conditions and the following disclaimer in the documentation and/or other materials provided with the distribution.
- Neither the name of the Xiph.org Foundation nor the names of its contributors may be used to endorse or promote products derived from this software without specific prior written permission.

THIS SOFTWARE IS PROVIDED BY THE COPYRIGHT HOLDERS AND CONTRIBUTORS "AS IS" AND ANY EXPRESS OR IMPLIED WARRANTIES, INCLUDING, BUT NOT LIMITED TO, THE IMPLIED WARRANTIES OF MERCHANTABILITY AND FITNESS FOR A PARTICULAR PURPOSE ARE DISCLAIMED. IN NO EVENT SHALL THE FOUNDATION OR CONTRIBUTORS BE LIABLE FOR ANY DIRECT, INDIRECT, INCIDENTAL, SPECIAL, EXEMPLARY, OR CONSEQUENTIAL DAMAGES (INCLUDING, BUT NOT LIMITED TO, PROCUREMENT OF SUBSTITUTE GOODS OR SERVICES; LOSS OF USE, DATA, OR PROFITS; OR BUSINESS INTERRUPTION) HOWEVER CAUSED AND ON ANY THEORY OF LIABILITY, WHETHER IN CONTRACT, STRICT LIABILITY, OR TORT (INCLUDING NEGLIGENCE OR OTHERWISE) ARISING IN ANY WAY OUT OF THE USE OF THIS SOFTWARE, EVEN IF ADVISED OF THE POSSIBILITY OF SUCH DAMAGE.



Manufacturer Model Name

2Din CD Premium	DPXGT714R
	DPXGT707L
	DPXGT707R
	DPXGT706L
	DPXGT706R
	DPXGT705L
	DPXGT704R
	DPXGT703L
	DPXGT702L
	DPXGT701R
	DPXGT700R
2Din Basic Audio	DPXGT502L
	DPXGT500R

### **For further information**

Please check the below special website for further information.  
<https://19cy.jvckenwood.com>



#### **TO OWNER**

Please retain this booklet and write the serial number of this product for identification and accurate reporting to your local police in the event of theft.

The serial number is labelled or stamped on the chassis.

Please confirm this number at your car dealer or service shop when the product has been reinstalled or exchanged to you after repair or readjustment.

Serial No.



ENGLISH

## Additional Copyrights

---

- Apple, iPhone, iPod, iPod classic, iPod nano, iPod touch, iTunes, and Lightning are trademarks of Apple Inc., registered in the U.S. and other countries.
- Android is a trademark of Google LLC.

INDONESIA

## Hak Cipta Tambahan

---

- Apple, iPhone, iPod, iPod classic, iPod nano, iPod touch, iTunes, dan Lightning adalah merek dagang dari Apple Inc., terdaftar di AS dan di negara lain.
- Android adalah merek dagang dari Google LLC.

MALAY

## Lampiran Hak Cipta Tambahan

---

- Apple, iPhone, iPod, iPod classic, iPod nano, iPod touch, iTunes dan Lightning adalah tanda dagangan Apple Inc., yang didaftarkan di A.S. dan negara-negara lain.
- Android ialah tanda dagangan Google LLC.

ภาษาไทย

## ลิขสิทธิ์เพิ่มเติม

---

- **Apple, iPhone, iPod, iPod classic, iPod nano, iPod touch, iTunes และ Lightning** เป็นเครื่องหมายการค้าของ Apple Inc., ซึ่งจดทะเบียนในประเทศไทยและประเทศอื่นๆ
- **Android** เป็นเครื่องหมายการค้าของ Google LLC

TIẾNG VIỆT

## Bản Quyền Bổ Sung

---

- Apple, iPhone, iPod, iPod classic, iPod nano, iPod touch, iTunes, và Lightning là thương hiệu của Apple Inc., được đăng ký ở Hoa Kỳ và các nước khác.
- Android là một nhãn hiệu của Google LLC.

中文

## 著作權聲明

---

- Apple , iPhone , iPod , iPod classic , iPod nano , iPod touch, iTunes 和 Lightning 是 Apple Inc. 在美國或其他國家冊的商標。
- Android 是 Google LLC 的商標。

العربية

## حقوق طبع محفوظة اضافيه

---

- تُعد Apple و iPhone و iPod و iPod classic و iPod nano و iPod touch و iTunes و Lightning علامات تجارية مسجلة لشركة Apple Inc. المسجلة في الولايات المتحدة ودول أخرى.
- Android هي علامة تجارية لشركة Google LLC.

PORTUGUÊS

## Direitos Autorais Adicionais

---

- Apple, iPhone, iPod, iPod classic, iPod nano, iPod touch, iTunes e Lightning são marcas registradas da Apple Inc., registradas nos EUA e em outros países.
- Android é uma marca registrada da Google LLC.

ESPAÑOL

## Derechos de Autor adicionales

---

- Apple, iPhone, iPod, iPod classic, iPod nano, iPod touch, iTunes y Lightning son marcas comerciales de Apple Inc., registradas en los EE. UU. y en otros países.
- Android es una marca comercial de Google LLC.

FRANÇAIS

## Droits d'auteurs additionnels

---

- Apple, iPhone, iPod, iPod classic, iPod nano, iPod touch, iTunes et Lightning sont des marques commerciales d'Apple Inc., déposées aux États-Unis et dans d'autres pays.
- Android est une marque de Google LLC.